



RS-600 (MKII) REACTION STATION.

INSTRUCTION BOOK

Please take your time to read this Instruction book in order to understand the safe and correct use of your new Electrothermal product.

It is recommended the Responsible Body for use of this equipment reads this Instruction book and ensures the user(s) are suitably trained in its operation.

Section 1.	Introduction.	Page 3
Section 2.	Symbols and using this Instruction book.	Page 4
Section 3.	Safety Information.	Page 5
Section 4.	Unpacking and Contents.	Page 7
Section 5.	Installation.	Page 8
Section 6.	Environmental protection.	Page 11
Section 7.	Production Operation.	Page 12
Section 8.	Technical Specifications.	Page 15
Section 9.	Maintenance	Page 16
Section 10.	Customer Support	Page 18
Section 11.	Parts and Accessories.	Page 19
Section 12.	Notes.	Page 21
Section 13.	EC Declaration of Conformity	Page 24
Appendix 'A'	Decontamination certificate	Page 20

© The copyright of this instruction book is the property of Bibby Scientific Limited. This instruction book is supplied by Bibby Scientific Limited on the express understanding that it is to be used solely for the purpose for which it is supplied. It may not be copied, used or disclosed to others in whole or part for any purpose except as authorised in writing by Bibby Scientific Limited. Bibby Scientific Limited reserves the right to alter, change or modify this document without prior notification.

In the interest of continued development Bibby Scientific Limited reserve the right to alter or modify the design and /or assembly process of their products without prior notification.

This product is manufactured in Great Britain by Electrothermal, part of the Bibby Scientific Group of companies.

1. INTRODUCTION.

- 1.1. This product is designed to meet the demands of today's modern laboratory and has been meticulously designed to provide years of service when used as described in the following pages. This product is a 6-positioned heat and stir reaction station designed for use with 56mm diameter glass vessels. Smaller diameter vessels can also be accommodated using optional reducer sleeves. (See *Parts and Accessories section 11*).
- 1.2. At the heart of this product is an innovative, firmware package designed to provide enhanced, accurate temperature control of block or vessel content. Temperatures are sensed either by a high precision platinum sensor embedded within the vessel block, or via the optional external probe supplied separately. A microprocessor constantly monitors temperature change many times per second. The products temperature range is from ambient to +250°C.
- 1.3. This product comes equipped with 'Reverse Stir' facility. A feature that allows the vessel stirring to be stopped and restarted in the opposite direction.
- 1.4. This product can interface with a robotic workstation or similar application. Connection is made via the RS232 or RS485 sockets. The unique 'Auto Detection' feature senses the interface connection and adjusts the set up characteristics accordingly.
- 1.5. Linked DC motors provide optimum speed control and sensitivity to drive the stir facility. High performance magnetic sensors carefully measure speed control via a feed back loop controlled by quartz oscillator and a microprocessor. The stir speed range is 400 – 2000rpm.
- 1.6. Optional PC based control software is supplied for advanced use with this product. RS600s are connected via the RS232, 9 way D socket / Plug data cable available as an accessory (See *Parts and Accessories section 11*). Stir / heat profiles can be preset with any number of commands over varying time delays. This provides the end user with infinite control over the application.
- 1.7. The vessel block is aluminium with a Teflon coating. The raised case walling reduces heat loss, which improves energy efficiency and adds to the protection of the user.



















2. SYMBOLS AND USING THIS INSTRUCTION BOOK.

2.1. Throughout this Instruction book the following symbols are shown to identify conditions which pose a hazard to the user or to identify actions that should be observed. These symbols are also shown on the product, or its packaging. When a symbol is shown next to a paragraph or statement it is recommended the user takes particular note of that instruction in order to prevent damage to the equipment or to prevent injury to one's self or other people.

The Responsible Body and the Operator should read and be familiar with this Instruction book in order preserve the protection afforded by the equipment.

To prevent injury or equipment damage it is the manufacturer's recommendation that all persons using this equipment are suitably trained before use.

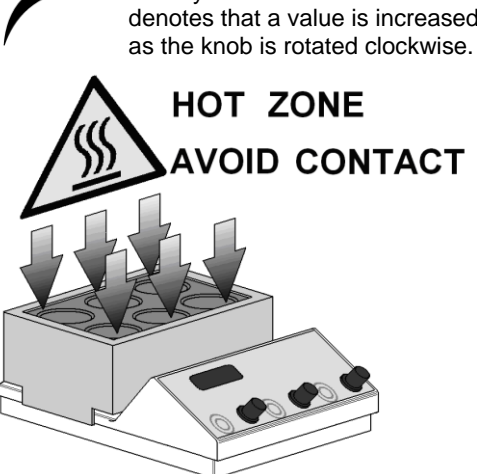
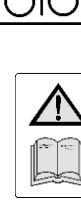
2.2. Symbols defined.

	Caution, risk of danger. See note or adjacent symbol.		This symbol denotes this section of the fascia is designated for the control of the heating function.
	Protective conductor terminal to be earthed. (Do not loosen or disconnect).		This symbol denotes this section of the fascia is designated for the control of the stirring function.
	Caution / risk of electric shock		This On / Off symbol means the LED is indicating the presence of mains electricity.
	Recyclable Packing Material		This symbol denotes the control knob is used to set the temperature.
	Do not dispose of product in normal domestic waste.		This symbol adjacent to an LED indicates when a function is in operation.
	Caution. Hot surface.		This symbol adjacent to an LED means the control functions are being set or the serial communication is in operation.
	Reverse stir function.		This symbol denotes the control knob is used to set the 'Ramp Rate'.
	This symbol above a control knob denotes that a value is increased as the knob is rotated clockwise.		This symbol indicates the plug position of data transfer.
 <p>HOT ZONE AVOID CONTACT</p>			Refer to Instruction book.
			Bio Chemical Hazard. Caution required. Will require decontamination.

3. SAFETY INFORMATION.

This product has been designed for safe operation when used as detailed in accordance with the Manufacturer's instructions.

NOTE: Failure to use this equipment in accordance with the manufactures operating instructions may compromise your basic safety protection afforded by the equipment and may invalidate the warranty / guarantee. The warranty / guarantee does not cover damaged caused by faulty installation or misuse of the equipment

3.1. Prevention of Fire and Electric Shock.



To prevent a risk of fire or electric shock, **DO NOT** open your *product* case without authorisation. Only Qualified Service Personnel should attempt to repair this product.



Replace fuses only with the type as listed in section, 'Technical Specifications and Parts and Accessories' (See fuse type and rating).



Ensure the Mains Power Supply conforms to rating found on the data plate located on the right hand side of this product.



Never Operate this equipment without connection to earth / ground. Ensure the mains supply voltage is correctly earthed / grounded in accordance with current area legislation.

3.2. General Safe Operating Practice.



Always follow good laboratory practice when using this equipment. Give due recognition to your company's safety and legislative health & safety procedures and all associated legislation applicable to your areas of operation. Check laboratory procedures for substances being heated and ensure all hazards (e.g. explosion, implosion or the release of toxic or flammable gases) that might arise have been suitably addressed before proceeding. When heating certain substances the liberation of hazardous gases may require the use of a fume cupboard or other means of extraction.



Do not position the product so that it is difficult to disconnect from the mains supply.



Do not touch the heating block or any glass vessel whilst in use.



Do not lean or stretch over equipment, glassware and fixings when in use.



Do not immerse unit in water or fluids.



Do not spill substances onto the heating block. If spillage does occur, disconnect unit from mains supply and follow instructions as detailed in Maintenance. (Section 9).



Do not cover this product whilst in use. **Do not** block or obstruct ventilation slots / airways.



Do not leave equipment switched on without a charged flask(s).



It is not recommended to leave any heating apparatus unattended during operation.



Only use Original Equipment manufactures spares and accessories. Ref Section 11.



This equipment will generate magnet fields. Keep all metal objects and magnetic data devices (e.g. credit cards) away from the stirrer unit.



The equipment is not spark, flame or explosion proof and has not been designed for use in hazardous areas in terms of BSEN 60079-14:1997. Keep flammable, low flash point substances away from the apparatus.



Do not operate or handle any part of the product with wet hands.



Keep the Mains cord and moulded IEC plug and lead set away from the heating surface.

4. UNPACKING AND CONTENTS.

4.1. Please check the contents of your carton against the diagram.

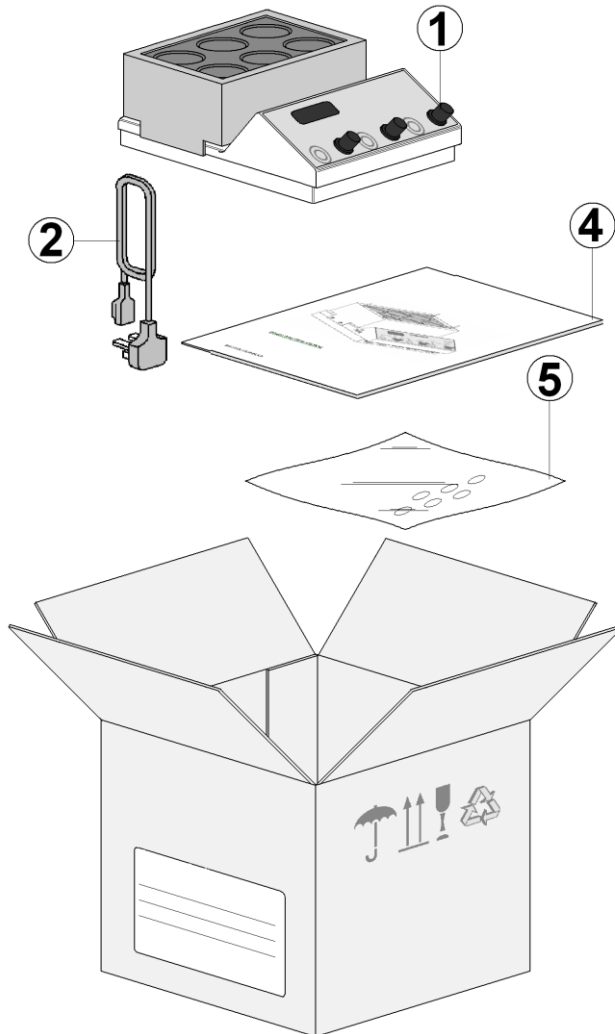

Item	Description	Qty
1	RS600 Product	1
2	Mains Cord and Lead set <small>(May be different from illustration)</small>	A/R
4	Instruction book	1
5	Stir Bars (Pkt 6)	1

<p>For future reference please record your products Serial and Model Numbers.</p>	<p>Serial Number</p>	<p>Unit Model/Cat Number</p>
--	-----------------------------	-------------------------------------

5. INSTALLATION.

5.1. Electrical safety and installation.

5.1.1. This equipment is designed to be used safely under the following conditions:-

- Indoor use.
- Altitude up to 2000 meters.
- Temperatures between 5°C and 40°C.
- Maximum relative humidity 80% for temperatures up to 31°C decreasing linearly to 50% relative humidity at 40°C.
- Mains supply voltage fluctuations up to $\pm 10\%$ of the nominal voltage.
- Transient over voltages typically present on the mains supply.
- Applicable rated pollution degree 2.



5.2. This equipment must be earthed / grounded to a fixed earth / grounded mains socket outlet. The mains supply is to earthed / grounded in accordance with current legislation.

5.3. Ensure only the correct rated mains input fuses are fitted. (Where applicable ensure the correct Mains cord and moulded IEC plug and lead set fuse if fitted). See Technical Specification Section 8 of this Instruction book.

5.4. Check the voltage on the data label of this product. Ensure the rating conforms to your local supply.

5.5. It is recommended this product be connected to a mains supply source which incorporated a RCD or GFCI device.



5.6. Do not install this product or accessories on a surface which may become wet or flooded.

5.7. The unit is supplied with a Mains cord and moulded IEC plug and lead set wired as follows.



Green / Yellow or **Green** = **Earth / Ground**

Blue or **White** = **Neutral**

Brown or **Black** = **Live / line hot.**



5.8. Install equipment is used on a clean, dry, non-combustible, solid work surface with at least 300mm suitable clearance all around from other equipment / objects.

5.9. Installation onto a Robotic System.

Note: *This activity should be undertaken in conjunction with the Instruction book supplied with the Robotic Work Station.*

Lift the RS600 carefully into the Robotic System ensuring the location pegs pass up through the location holes in the base of the RS600. Refer to Robotic System Guide for location peg adjustment. Refer to Robotic System Guide should the RS600 require clamping.

5.10. Serial Communication.

The RS600 (MKII) has two serial connections. These are as follows:-

The RS232: Is indicated by the label . This is a 9 pin D type socket connector as shown in the 'Connection Overview' illustration. Section 7.

The RS485 – GSIOC: Is indicated by the label . This is a 9 pin D type plug connector as shown in the 'Connection Overview' illustration. Section 7.

The RS600 (MKII) automatically recognises the connection port used and switches the configuration to the appropriate GSIOC or **STEM** protocol, baud rate and parity.

Note: *Only one connection at a time is permissible.*

The RS600 (MKII) will only switch automatically to GSIOC if it recognises a GSIOC signal. If the signal is not from a GSIOC source then the **STEM** protocol is switched on automatically by default with a fixed baud rate of 19200,8,N,1.

Default address after power up is a decimal 40. This can be seen on the display as "AD, 40".

Full technical specification of GSIOC and STEM protocol see "RS600 MKII Serial and Communication Protocol". This is available on request.

5.11. STEM® protocol (RS232 & RS485).

Stem command SET can be operated using RS232 or RS485 links. Baud rate is 19200, N, 8, 1 for STEM protocol. RS600 (MKII) has auto configuration for all parameters concerning the STEM protocol.

Command set as follows: -

AS	Set unit base address, applied after response	(0 to 99)
SE	Stirrer enabled	(0 to 1)
SR	Stir speed ramp rate (set rpm/time achieved – mins).	(1 to 10)
SS	Stir Speed (RPM)	(400 to 2000)
TE	Thermal control enabled	(0 to 1)
TT	Target temperature. (°C).	(0.0 to 153.9)
TR	Temperature Ramp rate (°C/min)	(0.0 to 5.0)

Note: For TR 0.0 indicates no control.

Query command set

QC	Request commanded variables
QD	Request debug variables
QF	Request system principal fixed values.
QM	Request measured data

Using a suitable terminal, type in and test some of the commands and query set, STEM protocol.

Examples of STEM Command protocol used.

"<CR>" Is a carriage return character.

Type in: >40 SE1 #0000 <CR>

Response: <40.00 OK <CR>

Result: Stirrer enabled (LED for stirrer ON< RS600 will commence stirring).

Type in: >40 SE0 #0000 <CR>

Response: <40.00 OK <CR>

Result: Stirrer disabled (LED for stirrer OFF, RS600 will stop stirring).

Type in: >40 TT123,4 TE1 #0000

Response >40,00 OK <CR>

Result Target temperature set to 123, 4°C, thermal control enabled (LED for ON< temperature will begin to raise block temperature).

Type in: >40 SS2000 SE1 SR2 #0000 <CR>

Response: <40,00 OK <CR>

Result: Stirring enabled, stirring speed set to 2000 rev/min, Stirrer ramp rate set to 2, (Stirring speed will steadily increase to 2000 rev/ min over 2 minutes).

GSIOC is a different control command set used in conjunction with Gilson branded handling systems.

6. ENVIRONMENTAL PROTECTION.

- 6.1. Maximum consideration has been given to environmental issues within the design and manufacturing process without compromising end product performance and value.



- 6.2. Packaging materials have been selected such that they may be sorted for recycling.



- 6.3. At the end of your product and accessories life, it must not be discarded as domestic waste. Ref: EU Directive 2002/96/EC on Waste Electrical and Electronic Equipment Directive (WEEE). Please contact your distributor / supplier for further information. For end users outside of the EU consult applicable regulations.

- 6.4. This product should only be dismantled for recycling by an authorised recycling company.



This product and accessories must be accompanied by a completed Decontamination Certificate prior to any disposal. Copies of the Certificate are available from your distributor of Bibby Scientific products, or you may copy and enlarge from 'Appendix A' of this instruction book.

Bibby Scientific's Electrothermal branded product range is registered with the Environment Agency under the name of as Electrothermal Engineering Limited as being a producer of WEEE (Waste Electronic and Electrical Equipment) through b2b Compliance, an authorised waste collection compliance scheme.

7. PRODUCT OPERATION.

7.1. The illustrations below show detailed layouts of the RS600.

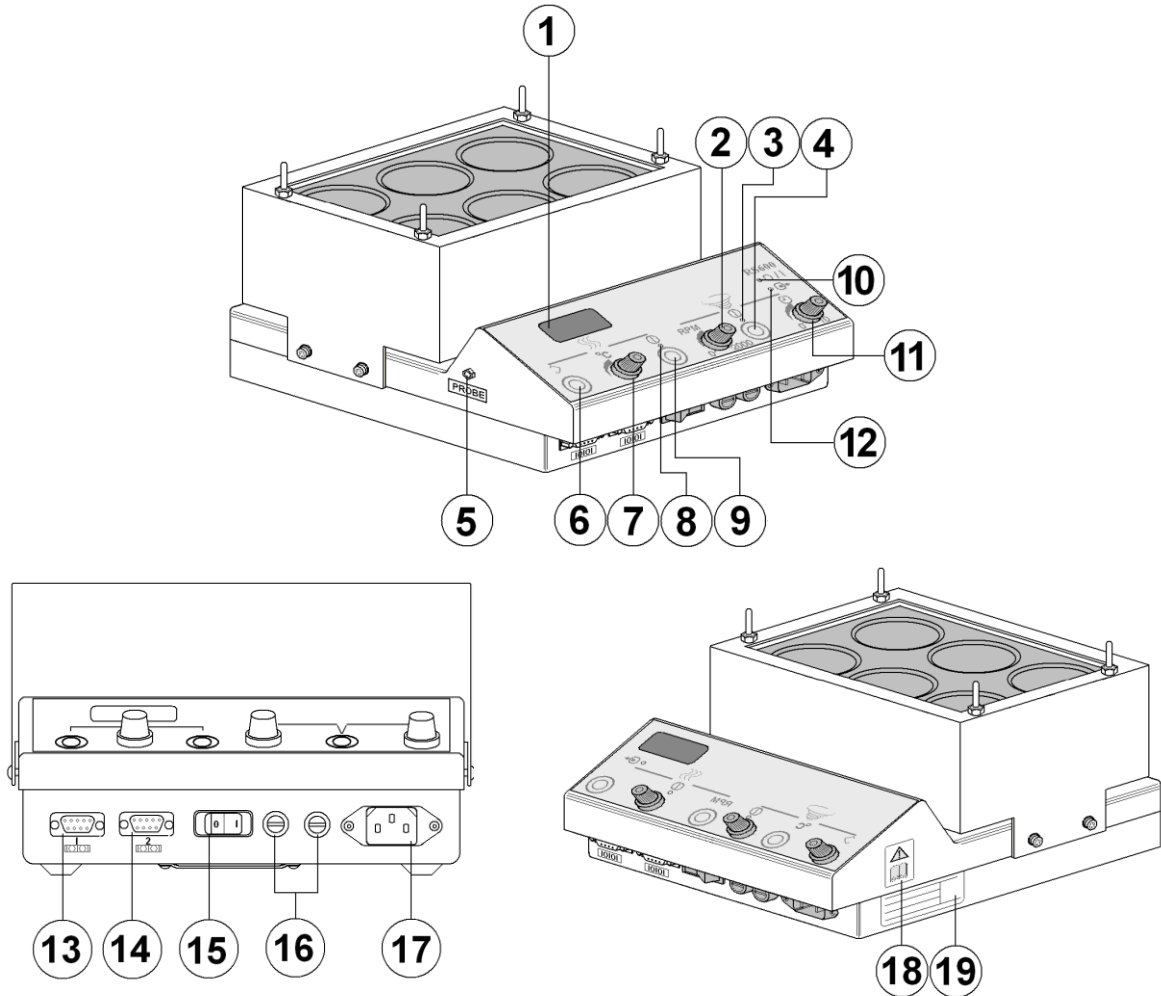

- | | | | |
|---|-----------------------------------|----|--|
| 1 | LED Temperature Display | 10 | Stir On / Off selection button |
| 2 | Stir speed control knob | 11 | Mains power present LED |
| 3 | Stir function On indication LED | 12 | Function Set LED |
| 4 | Stir speed Ramp rate setting. | 13 | RS232 connection |
| 5 | Probe socket | 14 | RS485 /GSIOC connection |
| 6 | Temperature selection button | 15 | On/ Off power switch |
| 7 | Temperature control knob | 16 | Fuse holders and fuses. (see section 11 Parts and Accessories). |
| 8 | Heater On / Off LED | 17 | Mains Input IEC socket. |
| 9 | Heater On / Off Selection button. | 18 | Instructions book label. |
| | | 19 | Data plate. |

- 7.2. Plug the mains cord with the moulded IEC plug into the IEC socket of the RS600.
Connect the mains plug to the correct voltage mains supply. Check data plate for correct voltage input.
- 7.3. Turn on the mains electricity and turn on the RS600 by the On / Off power switch.
- 7.4. The power on LED will illuminate and the display will successively display the following information commencing with:-

FIRMWARE VERSION..... e.g. F1.1

ADDRESS..... Address for serial communication.
 (Set automatically).

INITIALISATION..... (Always 0).

TARGETED STIRRING SPEED..... Final speed for stirring.

STIR RAMP RATE..... Time taken to achieve desired speed.

MEASURED BLOCK TEMPERATURE. Reaction vessel block temperature in °C.

LED Indication.

The LED next to the symbol  has a double function. It indicates serial communication when using GSIOC or "PC control" Software. It also indicates when a setting is taking place.

Sound Indication: - A short 'Beep' gives indication of parameter change. Long 'Beep' gives warning of error.

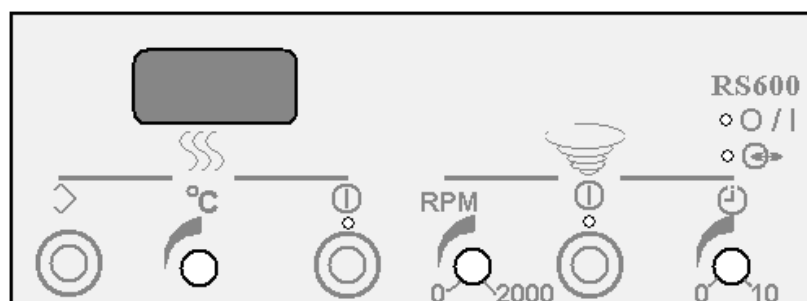



Control panel overlay.

7.5. Heating Function & Controls. 

The left side of the console panel is indicated by the symbol  and houses the controls for heating. The heating display provides continuous update of the measured temperature.

The membrane button with On / Off symbol  controls whether heaters are in the on or off state. The required temperature can be set to an accuracy of one decimal place.

To set an integer temperature, continually push down the 'Set' membrane button indicated by the symbol  and turn the rotary knob next to it clockwise or anti-clockwise until the desired temperature is displayed. To set the decimal part of the temperature tap the  set membrane button for every increment of 0.1°C until the

required temperature figure is displayed. (*The display will scroll through from 0 to 9 inclusive*).



7.6. Temperature Probe facility (Optional).

The RS600 has a jack plug socket for the connecting an external probe. (Optional accessory). When the external probe is connected the internal temperature sensor is overridden. This external probe becomes the sole means for controlling the RS600 temperature. The display will show the temperature of the external probe.

When using the external probe ensure the tip is immersed in the fluid sample to a minimum depth of at 20mm.

7.7. Stirrer Functions.





The right hand section of the console panel is indicated by the symbol  and has the controls for the stir facility set up. Rotational speed is measured in RPM (revolutions per minute). To set the rotational speed, turn the rotary control knob until the desired speed is shown in the display. To turn the stir function On / Off press the membrane button indicated with the symbol .

To reaffirm the set stirring speed when in operation, a small adjustment of the RPM rotary knob will display the current stirring speed.

7.8. Ramp Rate Function



The Ramp rate is measured as acceleration over time (minutes). The Ramp rate feature is shown by the clock symbol , when set greater than 1 minute it will linearly accelerate the stirring speed over the time set. To turn the stir function and ramp rate On / Off press the membrane button indicated with the symbol .

7.9. Reverse Stirr function



The RS600 now features reverse stir facility. When this feature is in operation the stir direction will change every 1 minute with a pause of 5 seconds before commencing re-stirring in the opposite direction. To select the reverse stir facility press and hold down the stir function membrane button until the LED above the button starts to flash on and off.

When the Ramp rate is set the reverse stir facility will still operate. Set the ramp rate as described in paragraph 7.8. Select the reverse stir facility. Once the desired stir speed has been achieved the unit will continue to stir depend of ramp rate time. The unit will now stop stirring and pause for 5 seconds before commencing the stir function in the opposite direction.

8. TECHNICAL SPECIFICATIONS.

8.1. Specification.

Mains Supply Power.	230V-AC or 115/100V-AC @ 50/60Hz
Mains Power Lead set (UK) 13A BS1362	3 core earthed / ground. 2 meters long Moulded IEC plug and Lead set – supply cord H0 V V-F- Replace only with equivalent cable.
Mains Power Lead set (Europe)	3 core earthed / ground. 2 meters long Moulded IEC plug and Lead set – supply cord H0 V V-F- Replace only with equivalent cable.
Mains Power Lead set (USA)	3 core earthed / ground. 2 meters long Moulded IEC plug and Lead set – supply cord SJT VW 1- Replace only with equivalent cable.
Lead set plug fuse (UK – only)	13A
Power Consumption	600W
Operating Ambient Temperature	5°C to 40°C
Heating Temperature Range	Ambient + 5 to 250°C
Display	4 x Red 7 Segment LED
Fuse Type and Rating	230V~AC F5A Quick Blow 1 ¼” 115 / 100V ~ AC F8A Quick Blow 1 ¼”
Number of Vessel positions	6
Vessel diameter	56mm – may be reduced by the use of optional adapter sleeves.
Well diameter	57.5mm
Stirring Rate	Off and variable 400 to 2000 RPM.
Ramp Start	Ramp start to set speed can be set for 1 to 10 minutes
Reverse Stir	Stir for 1 minute, pause for 5 seconds and reverse stir for 1 minute. Repeat cycle.
Stirring speed accuracy	±0.5%.
Temperature stability	±0.2°C (Still air, under no load condition).
Interface	RS232, RS485 / GSIOC
Connection	9-way 'D' type socket / plug for connection to the serial port of a laboratory computer or liquid handling system.

8.2. The Ingress protection rating for this product is classified as IPX1.

8.3. Dimensions & Weight.

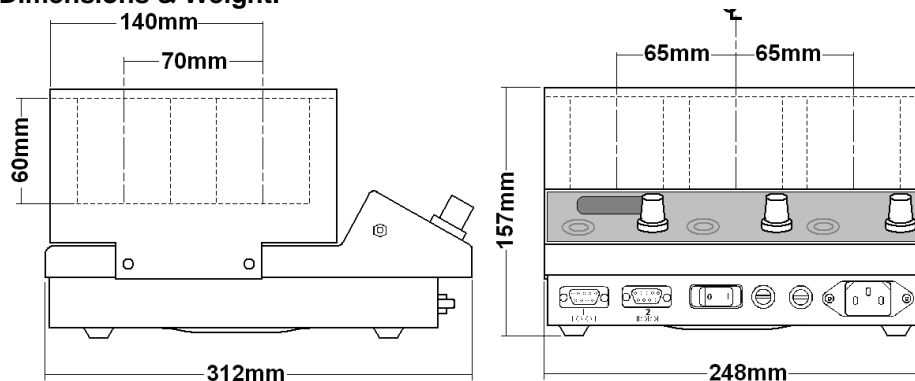

Weight (unpacked – RS600 only) **10.0 Kg.**

9. MAINTENANCE.

9.1. General Information.

 Unplug the unit from the mains voltage supply and allow it to cool before undertaking any maintenance tasks.

 **Maintenance should only be carried out under the direction of the Responsible Body, by a competent electrician. Failure to do so may result in damage to the product and in extreme cases be a danger to the end user.**

With proper care in operation this equipment has been designed to give many years of reliable service. Contamination or general misuse will reduce the effective life of this product and may cause a hazard.

Maintenance for the unit should include:

- Periodic electrical safety testing (an annual test is recommended as the minimum requirement).
- Regular inspection for damage with particular attention to the mains lead and plug set.
- Routine cleaning of the equipment should be undertaken using a clean cloth.

DO NOT USE SOLVENTS FOR CLEANING ANY PART OF THIS EQUIPMENT.

9.2. Fuse Replacement.

The mains fuse holders are located at the rear of this product. Refer to Technical specification, 'Fuse Rating' for correct fuse type and rating. Turn this product off and disconnect it from the mains supply. ① Unscrew both fuse holder caps from the fuse housings and ② remove the fuses. Inspect fuse for damage. Fit replacement fuse(s) and refit into fuse housing. (See 8.1 for fuse type and specification).

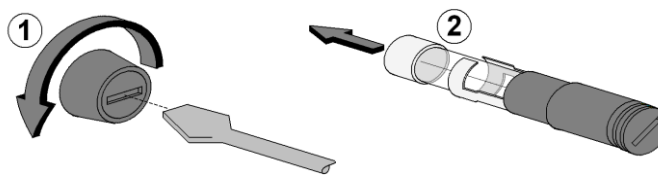

9.3. Fault Conditions.

Err A:	Temperature control probe short circuit.
Err B:	Temperature control probe open circuit.
Err C:	External probe error. (Probe may have been removed from the sample).
Err D:	Motor error failure.
Err E	General error.

9.4. Servicing.

This product should be serviced by a Electrothermal Service Engineer or by an agent on behalf of the manufacturer. If in doubt contact Electrothermal. See Section 10.

9.5. Spillage and Decontamination.

In the event of spillage switch off and unplug this product from the mains electrical supply. Wipe off all excess liquid from the reaction block and surrounding area using an absorbent soft cloth. Allow sufficient time for any ingressed liquid to evaporate before commencing with use.

If in doubt please consult Customer Support. Refer to section 10.



If the equipment has been exposed to contamination, the Responsible Body is responsible for carrying out appropriate decontamination. If hazardous material has been spilt on or inside the equipment, decontamination should only be undertaken under the control of the Responsible Body with due recognition of possible hazards. Before using any cleaning or decontamination method, the Responsible Body should check with the manufacturer the proposed method will not damage the equipment.

Prior to further use, the Responsible Body shall check the electrical safety of the unit. Only if all safety requirements are met can the unit be used again. The above procedure is intended as a guide. Should spillage occur with a toxic or hazardous fluid then special precautions may be necessary.

Decontamination Certificate.

Note: In the event of this equipment or any part of the unit becoming damaged, or requiring service, the item(s) should be returned to the manufacturer for repair accompanied by a decontamination certificate. **Copies of the Certificate are available from Distributor/Manufacturer. Appendix A of this instructions book may be copied and enlarged.**

At the end of life, this product must be accompanied by a Decontamination Certificate. See section 6.3 and 6.4

10. CUSTOMER SUPPORT

For help and support in using this product, please contact Customer Services at the following address.

Bibby Scientific Limited.

Beacon Road,
Stone,
Staffordshire ST15 0SA,
Great Britain.

Tel: +44(0)1785 812121
Fax: +44(0)1785 810405

- General enquiries :
info@bibby-scientific.com
- Order enquiries :
sales@bibby-scientific.com
- Technical support :
electrothermalhelp@bibby-scientific.com
- www.electrothermal.com

For the America's and Canada, contact:

Techne Incorporated, 3 Terri Lane,
Suite 10 Burlington, NJ 08016 USA.

Toll free:800-225-9243Tel: 609-589-2560
Fax: 609-589-2571
Email: labproducts@techneusa.com
Http www.techneusa.com

11. PARTS AND ACCESSORIES.

AZS4017	Fuse 5A (230V~AC Product)
AZS4024	Fuse 8A (115V~AC Product)
AZ6745	Mains cord and moulded IEC plug and lead set (UK).
AZ6746	Mains cord and moulded IEC plug and lead set (USA).
AZ6747	Mains cord and moulded IEC plug and lead set (Schuko).
AZS6107	Stir bar, Pack 6.
PS80087	Temperature Probe with jack plug.
PS80088	Reaction pot – flat bottom 3 neck jar
PS80113	Adapter sleeve 57.5mm to 25.4mm diameter pack of 6
PS80132	Adapter sleeve 57.5mm to 45.0mm diameter pack of 6
PS80134	Adapter sleeve 57.5mm to 35.0mm diameter pack of 6
PS80141	Adapter sleeve 57.5mm to 47.0mm diameter pack of 6
PS80142	Adapter sleeve 57.5mm to 50.0mm diameter pack of 6
AZS4255	9 way D socket / Plug data cable.

APPENDIX 'A'. DECONTAMINATION CERTIFICATE.

Bibby Scientific Limited. Beacon Road, Stone, Staffordshire ST15 0SA. Great Britain Tel: +44(0)1785 812121. Fax: +44(0)1785 810405 E-mail: electrothermalhelp@bibby-scientific.com		
<u>DECONTAMINATION CLEARANCE CERTIFICATE</u>		
For the Inspection, Repair or Return of Medical, Laboratory or Industrial Equipment.		
Prior to a Service Engineer working on equipment that has been in an environment where substances hazardous to health may have been used, you are requested to provide the following information:		
CUSTOMER DETAILS		
Company:-	Address:-	
Department:-		
Contact Name:-		
Tel No:-	Post Code:-	
Fax No:-		
<u>Product Description</u>		
Model No:-	Serial No:-	
Has the equipment been exposed to any of the following, Please answer all questions by deleting YES/NO as applicable and by providing details in section 2 below.		
A. Blood, body fluids, Pathological specimens	YES/NO	Provide details if YES
B. Biodegradable material that could become a hazard	YES/NO	Provide details if YES
C. Other biohazard	YES/NO	Provide details if YES
D. Chemical or substances hazardous to health	YES/NO	Provide details if YES
E. Radioactive substances State name(s) and quantities of isotopes and checks made for residual activity	YES/NO	Provide details if YES
F. Other hazards	YES/NO	Provide details if YES
2. Please provide details of any hazard present as indicated above. Include details of names and quantities of agents as appropriate:-		
3. Your method of decontamination (please describe):-		
4. Are there likely to be any areas of residual contamination (please specify)		
I declare that the above information is true and complete to the best of my knowledge and belief.		
Authorised signature:-	Name (please print):-	
Title/Position:-		
For and behalf of:-	Date:-	

12. NOTES.

13. EC DECLARATION OF CONFORMITY.

CE marked products and associated accessories covered by this Instruction book conform to the essential requirements of the following directives:

EMC Directive.

Low Voltage Directive.



Thank you for reading this data sheet.

For pricing or for further information, please contact us at our UK Office, using the details below.



UK Office

Keison Products,

P.O. Box 2124, Chelmsford, Essex, CM1 3UP, England.

Tel: +44 (0)330 088 0560

Fax: +44 (0)1245 808399

Email: sales@keison.co.uk

Please note - Product designs and specifications are subject to change without notice. The user is responsible for determining the suitability of this product.