



Manual No.AWK043-4
C922

FMC-40

OPERATING HANDBOOK

Contents

Description3-4
 Technical Specification 5
 Installation6-7
 Commissioning8-10
 Service - Routine Attention 10
 Table of Lower Explosive Limits13

ILLUSTRATIONS

Fig

1 Front View - Controls..... 14
 2 Mother Board Detail and Field Terminals15
 3 Alarm Board - Component Layout16
 4 Sensor Termination.....17

SYSTEM DATA

Manufacture date: -		Works Order No:-		
Sensor type: -	life:	life:	life:	life:
Gas: -				
Range: -				
Low alarm trip: -				
High alarm trip: -				
Fault Relay:- Normally Energised - Latched				
Alarm Relays:- Normally De-Energised - Latched				
Details: -				

DESCRIPTION

The FMC-40 is a multi channel combustible and toxic gas monitor, which can accommodate up to 4 sensor channels housed in wall mounting enclosure. Sensors may be added or removed as required, but should be carried out with the power to the unit switched off. Each sensor continuously monitors for gas, with the digital display sequentially sampling each sensor reading. Where a particular sensor reading requires to be viewed, the hold button should be pressed when the channel indicator is on the appropriate sensor, pressing the hold button again will restart the sampling sequence.

The gas alarms are activated at preset levels and will remain on until the gas clears, these in turn activate the appropriate alarm relays. The fault indicator is initiated should the sensor connecting lines become open/short circuit, or an electronic fault be detected.

The control unit requires an a.c. mains power supply and/or a low voltage d.c. power supply. When both are provided the low voltage d.c. acts as a standby supply in the event of an a.c. mains power failure.

HOLD (Fig.1) Pressing and releasing the button will hold the meter display on a particular sensor channel which is indicated by the amber L.E.D., press again to continue the auto step sequence.

RANGE INDICATORS Three range indicators are positioned directly above the panel meter %L.E.L. (Lower Explosive Level), PPM (Parts Per Million) and % Volume, each sensor is addressed to indicate its appropriate range.

MAINS ON LAMP (P) GREEN indicates that power is being supplied to the control unit.

When the optional standby battery is fitted loss of mains supply will result in the GREEN Mains ON Lamp changing to RED.

ALARM LAMPS C1, C2, C3, C4 - Lo and Hi RED illuminated when the gas concentration increases beyond the alarm trip points.

FAULT LAMP (F) AMBER illuminated in the event of a sensor cable fault or sensor supply circuit /electronic fault.

SOUNDER initiated in the presence of a fault or gas alarm condition.

TEST When pressed for 15 seconds alarm L.E.D'S are activated. If pressed for a further 15 seconds alarm relays will change state.

RESET used to mute the sounder and reset alarms, gas alarms cannot be reset until the gas concentration has decreased below the set alarm level.

ALARM RELAY INHIBIT Pressing the reset pad for 15 seconds will inhibit the alarm relays which is indicated by the fault light coming on. To remove the inhibit press the reset pad for 15 seconds, the fault light will turn off.

ZERO POTENTIOMETER meter zero adjust when the sensor is monitoring a gas free atmosphere.

SPAN POTENTIOMETER used to adjust the meter indication to read correctly when the sensor is subject to a test gas of known concentration.

ALARM SET SWITCH alarm trip points setting.

SENSOR CURRENT POTENTIOMETER sensor supply adjustment.

Technical specification

NUMBER OF CHANNELS

One, Two, Three or Four channels

OUTPUTS

Common Relays - user selectable

High alarm RL2 - D.P.C.O. normally energised or de-energised - factory set de-energised
Latched or unlatched - factory set latched
Low alarm RL1 - D.P.C.O. normally energised or de-energised - factory set de-energised
Latched or unlatched - factory set latched
Fault alarm RL3 - S.P.C.O. normally energised or de-energised - factory set de-energised
Latched or unlatched - factory set latched
General Alarm Relay RL4 - S.P.C.O. changes on all alarms and is resettable at all times.

Channel Relay - user selectable

Selectable high or low alarm S.P.C.O. normally energised or de-energised
- factory set low de-energised
Latched or unlatched - factory set latched
All contacts rated 5A/230v AC
Analogue output 4~20mA into 200 ohms max load

SENSOR CABLE

Flammable (catalytic) - 3 core, 1.5mm screened cable, mineral insulated copper sheathed or steel wire armoured – maximum cable loop resistance 20 ohms.
Transmitter – 3 core 0.5 mm minimum screened cable, mineral insulated copper sheathed or steel wire armoured – maximum cable loop resistance 200 ohms.

POWER SUPPLY

230, 110v, AC 50/60Hz. or 24v DC (21-30 volts tolerance)

POWER CONSUMPTION

Per channel
Normal operating condition 3w
Full alarm condition 4.5w

OVERLOAD PROTECTION

1A fuse - AC
1 amp anti-surge fuse - DC
2 amp anti-surge fuse - Batteries.

ACCURACY

±5% F.S.D

REPEATABILITY

±2% F.S.D

ENVIRONMENTAL

Ambient operation temp. 0 to 50 degrees centigrade
Storage temperature -20 degrees to +60 degrees centigrade
Humidity range 0 to 90% RH
Case Ingress Protection IP52 - Option IP65

MISCELLANEOUS

CE Cert No. C511
Dimensions 310mm wide x 265mm high x 75mm deep
Weight 3.5kg

ADD ON OPTIONS:

Standby battery 1 hour - Field installation - position the batteries so that they are supported by the plastic base block and then retained using the tywrap, connect the battery connectors to terminal blocks JP11 and JP12.

Installation

The FMC-40 Series control instrumentation is designed for installation in a safe area only. Siting of the instrument should be chosen with regard to the following points:

- (a) Cable within the enclosure should be cut back to the minimum length and having been terminated should be kept away from electronic components and the ribbon cable. Cable requiring to pass from the bottom of the enclosure to the top should be run down the right hand side adjacent to the enclosure metalwork.
- (b) Away from sources of local heat and with room for adequate ventilation.
- (c) Within easy reach and audible distance of operating personnel.
- (d) Convenient to a separately fused power supply.
- (e) Incoming sensor cables and outgoing alarm annunciation.
- (f) Sensor cables to be electrically shielded i.e. M.I.C.C., steel wire armoured, screened cable.

To prevent any effect from earth currents the cable shielding should be grounded at one end only.

The instrumentation should be subjected to a minimum of vibration and shock.

Ascertain the voltage rating of the power supply to which the instrument will be connected.

SITING THE SENSING HEADS

A key feature of the installation is the correct siting of the sensing head. Several considerations must be taken into account, the most important being the density of the gas.

Density (air = 1)

Acetone	2.0	n-Hexane	3.0
Ammonia	0.6	Hydrogen	0.1
Benzene.....	2.8	Methane	0.6
n-Butane	2.0	n-Octane	3.9
Carbon monoxide	1.0	n-Pentane	2.5
Ethane	1.0	n-Propane	1.6
Ethyl alcohol	1.6	Town gas	0.4-0.7
n-Heptane	3.5	Xylene	3.7

Under still air conditions, a 'lighter than air' gas such as methane leaking from a small orifice at ground level, will rise in a plume the shape of which approximates an inverted cone. As the gas rises, it draws air from the surroundings and creates a turbulence. Resulting from this there occurs rapid dilution and, unless a sensor is positioned within the plume, there will be no initial indication of a leak.

As gas continues to escape, the diluted concentration rises to ceiling level and begins to layer. In time the concentration at ceiling level will increase and this, in turn, will displace air downwards.

Dangerous levels will, therefore, tend to occur at ceiling level and the thickness of this layer will increase with the passage of time.

Ventilation of the room will of course alter the situation significantly but it should be remembered that if the ventilator is not at ceiling level, a dangerous concentration can still occur between the top of the ventilator and the ceiling.

For heavier than air gases such as propane or butane, the formation of dangerous layers occurs at ground level. These gases tend to behave like water and will run down gradients and pool at the lowest point.

The number of heads required in individual rooms is determined by the number of possible hazards in the vicinity.

Gas leakage may occur around valves, flanges and anywhere where gas pipes are jointed. It may be possible to cover several probable gas leaks in one room by the careful siting of a single head. Cable ducts, trenches and manholes are also likely places where a build up of heavy gases may collect.

When siting a head in such places it is most important to ensure that there is no likelihood of flooding by water, or excessive dust which may block the sintered disc and prevent gas reaching the sensor.

When monitoring gases outside, those lighter than air will be quickly dispersed, but gases heavier than air will tend to form in layers and again cause a dangerous hazard. When siting heads outside prevailing winds must be taken into consideration and adequate protection given against wind and rain.

POISONING OF CATALYTIC SENSORS

Catalytic elements used in flammable gas sensors are liable to be rendered inactive due to 'poisoning' by certain groups of compounds.

In general contact with any gaseous compound capable of producing an involatile residue upon heating is to be avoided.

Examples of such substances are:

- a. Silicon containing vapours, as emitted by silicone polishes, greases and oils.
- b. Petroleum vapours containing tetra-ethyl lead or other organo-metallic compounds.
- c. Phosphorus in the form of phosphate esters.

These compounds will permanently affect the detector and if their presence is suspected the response of the detector should be determined by the calibration procedure.

It is also possible that the reaction of the detector to a flammable gas could be inhibited by halogen containing gases such as chloroform, carbon tetra chloride and trichloro-ethylene. this effect is not permanent.

Commissioning

Before applying power to the instrument ensure that all detector heads are connected to the sensor terminals on the printed circuit board (fig 2) and that each detector head is connected to its appropriate channel, identified by a small circular, coloured label:

WARNING – DO NOT INSERT OR REMOVE ALARM CARDS FROM THE MOTHERBOARD WHILE THE POWER IS ON

Red	=	flammable
Yellow	=	toxic
Blue	=	oxygen
Green	=	others

Switch on power to the instrument.

Check that the green 'P' power lamp is on.

Each channel alarm card has a green (ACTIVE) indicator located on the mother board (D102, D202, D302, D402). On power up these will flash for 60 seconds indicating that the sensors are stabilising, during this period all alarms are held in the off condition.

Where an internal standby battery has been supplied the connectors should be made on JP11 and JP12.

Re-set alarms by pressing the reset button located on the front panel.

Allow ten minutes for the sensors to stabilise.

Select channel 1 and for flammable or toxic sensors adjust meter to read zero by means of appropriate ZERO POTENTIOMETER marked (Z) on the alarm module, or for oxygen sensor adjust the s-span potentiometer for a reading of 20.8 repeat for Channel 2, 3 and 4.

CALIBRATION

Establish calibration figures with respect to the L.E.L. limit or the T.L.V. limit of the calibration gas being used. See page 13.

The following calibration gases are recommended:

Flammable gases - 2.5% methane in air. Toxic gases - T.L.V. When using this gas ensure adequate ventilation.

If necessary zero each detector channel in clean air (for ambient oxygen monitoring the meter should be adjusted to read 20.8% using the s-span potentiometer).

Apply the calibration gas to the appropriate head at a flow rate of approximately 1 litre per minute.

When the meter reads a steady value adjust the Span Potentiometer marked (S) to obtain the correct reading for the calibration gas being used.

SERVICE ADJUSTMENTS

The following adjustments need only be made if the standard factory settings (see test certificate) are to be adjusted.

CALIBRATION WHEN USING CV TRANSMITTER (4~20mA DEVICE)

Where a transmitter has been supplied the setting up procedure as described on page 18 or 19 should be followed. The standard transmitter for toxic sensors is supplied as a two wire device set in a loop powered mode, and the flammable sensor is supplied as a three wire device.

NOTE: Where a transmitter is used, adjustment of the alarm module calibration potentiometer is not required (factory set for 4~20mA input signals), gas calibration need only be carried out at the detector head end.

ALARM LEVEL ADJUSTMENT

1. Alarm levels may be adjusted as follows: -
For toxic/flammable gases zero the instrument in clean air using the zero potentiometer (for ambient oxygen monitoring the meter should be adjusted to read 20.8 using the s-span potentiometer).
2. Press the alarm set switch for approximately 5 seconds the sounder will bleep and the low alarm indicator will come on, the green power indicator will turn off, release the alarm switch.
3. Using the zero potentiometer adjust the digital display for the required low trip level reading, press the alarm set switch until the high alarm indicator comes on, release the alarm set switch.
4. Adjust the digital display to read the required high trip level reading and again press the alarm set switch both alarm indicators will come on.
5. Zero the digital display (toxic/flammable) or 20.8 for oxygen and press alarm set switch, alarm indicators will turn off and the green power indicator will turn on.

SENSOR SUPPLY ADJUSTMENT (CATALYTIC SENSOR)

Factory set – no further adjustment required unless a change of sensor type is being made.

For ease of setting, measurements are taken across a 1ohm resistor (located on each sensor board) which is connected in series with the supply to the detector head. Current required by each type of sensor is (VQ21-300mA/VQ23 DCP-335mA) therefore, measuring mV across the 1 ohm resistor at test point TP1 or TP2 (on the mother board) and sv test point on each sensor board, will provide a mV reading proportional to mA's supplied, adjustment may be carried out using the sensor volts adjustment potentiometer.

Alternatively the sensor voltage may be set at the detector head across terminals P and W (VQ21 2v/VQ23 DCP 2.5v) and again use the sensor volts adjust potentiometer.

4-20mA OUTPUT ADJUSTMENT

Adjustments: With the load connected to the appropriate 4~20-mA output terminal (typically 100 ohms) and a digital volt meter connected to the test pins TP3 + TP4 - ensure that the sensor is in clean air, and that the instrument is reading zero.

Adjust the 4mA potentiometer to read 4mV on the digital voltmeter.

Using the appropriate sensor zero potentiometer adjust the alarm panel digital display for full scale reading.

Adjust the 20mA output potentiometer until the digital voltmeter reads 20mV

Return the alarm panel digital display reading to zero by readjusting the zero potentiometer.

RANGE & SCALE SELECTION

The range and scale reading is normally factory set but where a sensor alarm board is to be added the following selections should be made on the display board PCN037.

Note: Power to the system should be off when adding or removing a sensor board.

RANGE

1. Range - for the appropriate channel select %L.E.L., %Vol. or PPM range by connecting the jumper across the indicated selector pins.
2. Scale - Select the scale required by connecting the jumper across the appropriate DP pins.

No jumper - Digital panel meter reading 100

DP1 - Digital panel meter reading 10.0

DP2 - Digital panel meter reading 1.00

Service – routine attention

The owner or occupier of the premises should place the supervision of the system in the charge of a responsible executive whose duty it should be to ensure the day to day operation of the system and to lay down the procedure for dealing with a gas alarm or fault warning. To ensure reliability an agreement should be negotiated for regular servicing. When a service contract cannot be arranged an employee with suitable experience of electrical equipment should be trained to deal with the more simple servicing and instructed not to attempt to exceed the scope of such training.

Liaison should be established with those responsible for maintenance of the building fabric or redecoration etc. to ensure that their work does not cause a fault or otherwise interfere with the operation of the gas alarm installation. Particular attention appertaining to the Detector Head.

The operating instructions should be kept available preferably with the control unit, all faults, service tests and routine attention given should be recorded.

DAILY: A check should be made that any fault condition which may be indicated is in fact being attended to and that all other indicators are normal.

WEEKLY: In plants involving a high risk process or having gases which may cause loss of sensitivity a check on calibration should be carried out.

TWICE YEARLY MAINTENANCE SCHEDULE

1. All zeros at the control unit to be checked, logged and aligned.
2. Each detector to be gas tested and reading logged (sensitivity checked).
3. Field indicators to be tested.
4. All alarm set points checked and re-aligned.
5. Lamp Test.
6. All faulty parts replaced where required.
7. All filter elements checked and replaced as necessary.
8. Power supply - complete functional check.
9. Visual inspection made to confirm that all cabling fitting and equipment is secure, undamaged and adequately protected.

FAULT DIAGNOSIS

- Unable to zero meter
1. Sensor open circuit
 2. Sensor leads incorrectly connected
 3. Alarm card not positioned correctly
- No front panel indication - Check ribbon cable is connected correctly

ACTION TO BE TAKEN IF THE APPARATUS ALARM SOUNDS: -

- A Extinguish all naked flames, including all smoking materials.
- B Turn off all gas appliances.
- C Do not switch on or off any electrical lights or appliances.
- D Turn off the gas supply at the gas emergency control and/or (with L.P.G supply) the storage tank.
- E Open doors and windows to increase ventilation

If the alarm continues to operate, even after an alarm re-setting action where appropriate, and the cause of the leak is not apparent and/or cannot be corrected, vacate the premises and immediately notify the gas supplier and/or the gas emergency 24 hour service in order that the installation may be tested and made safe and any necessary repair carried out.

Fig 1

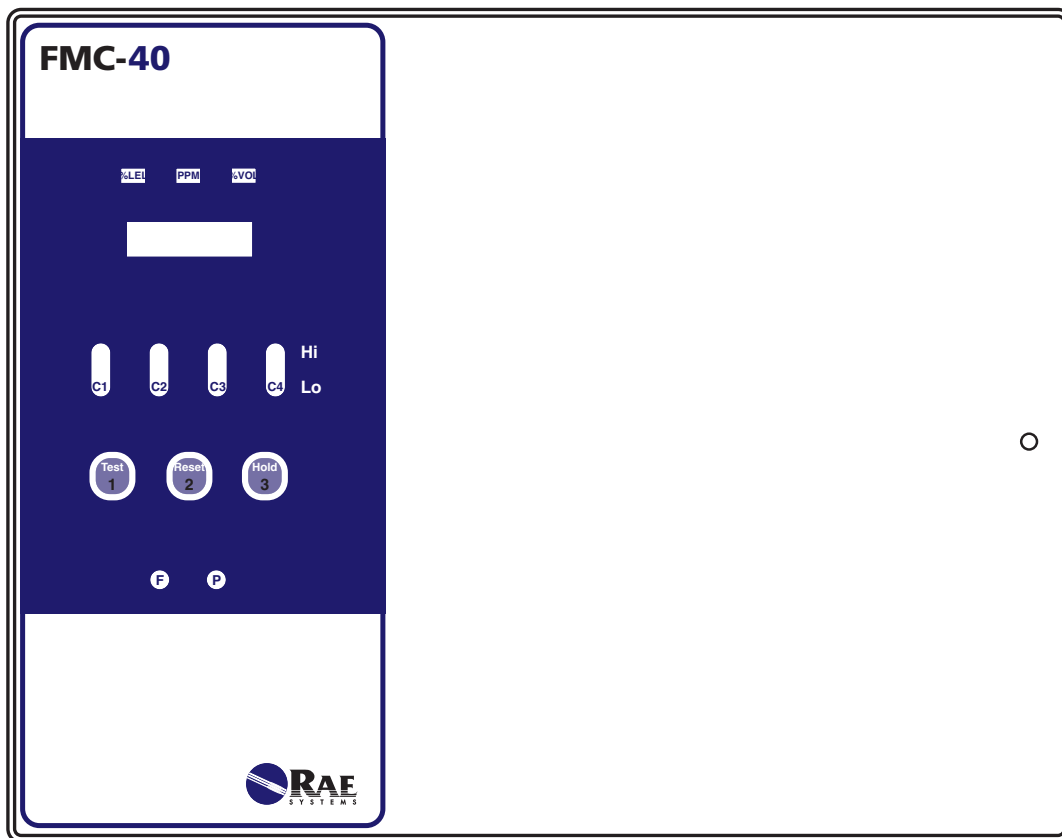

Range Indicator -

- L.E.L. - Lower Explosive Limit
- PPM - Parts Per Million
- % vol. - % Volume
- Hi - High Alarm
- Lo - Low Alarm
- C₁-C₄ - Channel Selection (Sensor)
- F - Fault Indicator
- P - Power On (Green)
- Mains Fail (Red)
- Hold - Channel Selection
- Reset - Sounder/Alarms
- Test - Electronic System Test

Fig 2

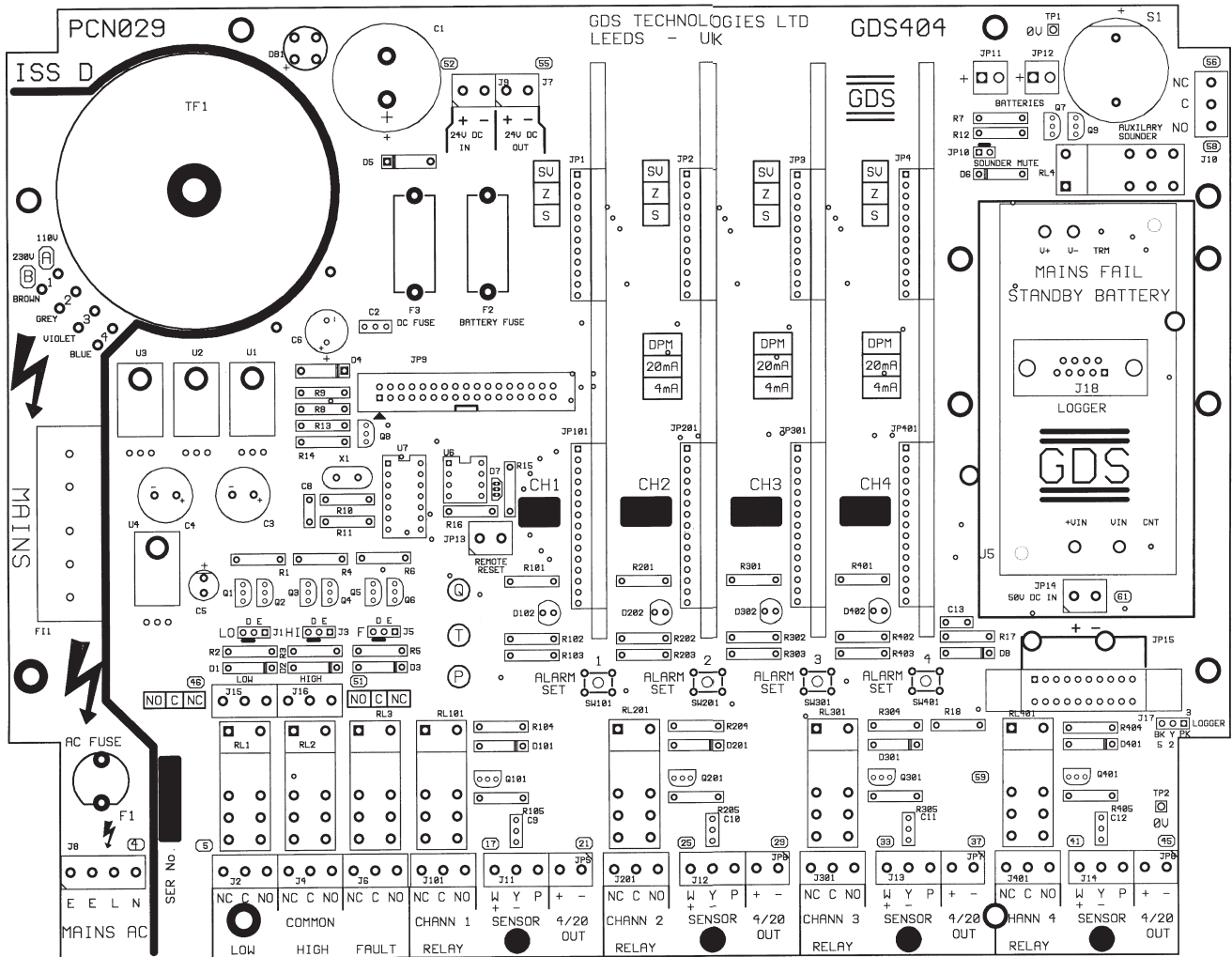

Mother Board

Relay Selection

Common High Relay - Normally energised/Normally de-energised - (J3)

Common Low Relay - Normally energised/Normally de-energised - (J1)

Common Fault Relay - Normally energised/Normally de-energised - (J5)

Sounder Permanent Mute - JP10 remove

Standby Battery - Connect leads to - (JP11 and JP12)

Fig 3

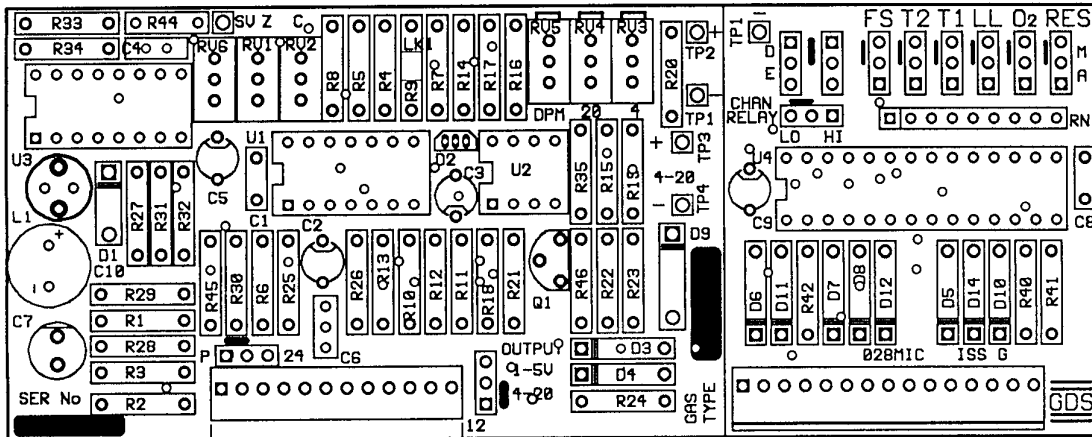

Alarm Board

Relay Selection

Channel Relay - Low/High Alarm - Lo/Hi

Normally energised or de-energised - E/D

Automatic or Manual Reset - A/M

Oxygen Monitoring (factory set) - O₂

Oxygen Alarm Set Low/Low Alarm - LL

Time delay to alarm - T1 - 10 secs
T2 - 30 secs

When used with GDS300 Flow sample systems - FS

Sensor Selection - 24v (4/20mA input) P - Pellistor (mV input)

4~20mA Output - TP3/TP4

Calibration - TP1/TP2

Adjustments

Potentiometer	RV1 -	Sensor Zero
Potentiometer	RV2 -	Sensor Calibration
Potentiometer	RV3 -	4~20mA signal output - 4mA adjust
Potentiometer	RV4 -	4~20mA signal output - 20mA adjust
Potentiometer	RV5 -	FMC-40 display span (factory set)
Potentiometer	RV6 -	Sensor Supply

Fig 4

SENSOR – 3 WIRE

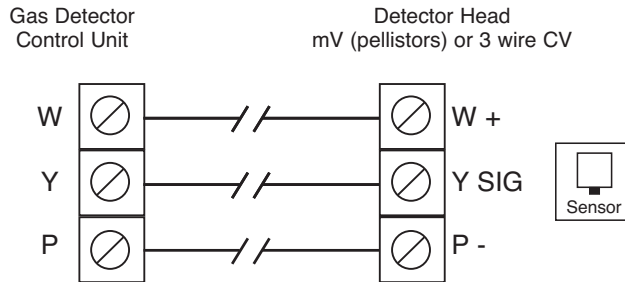

SENSOR – 2 WIRE

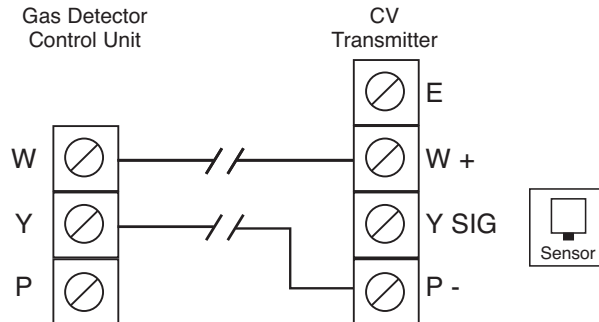

INFRA RED SENSOR – 3 WIRE

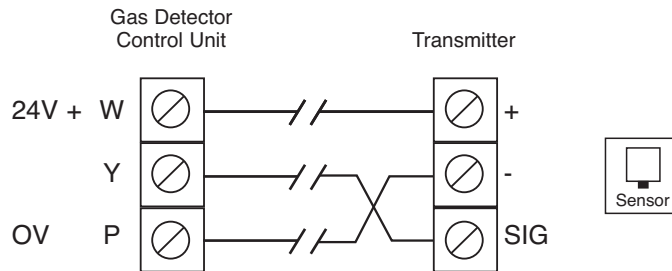

- RED ident – (R) = flammable
- YELLOW ident – (Y) = toxic
- BLUE ident – (B) = oxygen
- GREEN ident – (G) = others

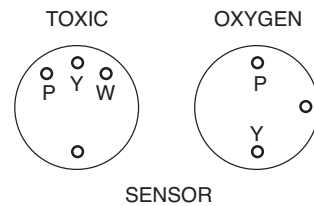



Thank you for reading this data sheet.

For pricing or for further information, please contact us at our UK Office, using the details below.



UK Office

Keison Products,

P.O. Box 2124, Chelmsford, Essex, CM1 3UP, England.

Tel: +44 (0)330 088 0560

Fax: +44 (0)1245 808399

Email: sales@keison.co.uk

Please note - Product designs and specifications are subject to change without notice. The user is responsible for determining the suitability of this product.