



GasAlertMicro 5 and GasAlertMicro 5 PID

O₂, CO, H₂S, PH₃, SO₂, Cl₂, NH₃, NO₂, HCN, ClO₂, O₃, VOC, and Combustibles

1, 2, 3, 4, and 5 Gas Detectors

Quick Reference Guide

"INNOVATORS IN GAS DETECTION"



BWF
Technologies

Limited Warranty & Limitation of Liability

BW Technologies LP (BW) warrants this product to be free from defects in material and workmanship under normal use and service for a period of two years, beginning on the date of shipment to the buyer. This warranty extends only to the sale of new and unused products to the original buyer. BW's warranty obligation is limited, at BW's option, to refund of the purchase price, repair, or replacement of a defective product that is returned to a BW authorized service center within the warranty period. In no event shall BW's liability hereunder exceed the purchase price actually paid by the buyer for the Product. This warranty does not include:

- a) fuses, disposable batteries or the routine replacement of parts due to the normal wear and tear of the product arising from use;
- b) any product which in BW's opinion, has been misused, altered, neglected or damaged by accident or abnormal conditions of operation, handling or use;
- c) any damage or defects attributable to repair of the product by any person other than an authorized dealer, or the installation of unapproved parts on the product; or

The obligations set forth in this warranty are conditional on:

- a) proper storage, installation, calibration, use, maintenance and compliance with the product manual instructions and any other applicable recommendations of BW;
- b) the buyer promptly notifying BW of any defect and, if required, promptly making the product available for correction. No goods shall be returned to BW until receipt by the buyer of shipping instructions from BW; and
- c) the right of BW to require that the buyer provide proof of purchase such as the original invoice, bill of sale or packing slip to establish that the product is within the warranty period.

THE BUYER AGREES THAT THIS WARRANTY IS THE BUYER'S SOLE AND EXCLUSIVE REMEDY AND IS IN LIEU OF ALL OTHER WARRANTIES, EXPRESS OR IMPLIED, INCLUDING BUT NOT LIMITED TO ANY IMPLIED WARRANTY OF MERCHANTABILITY OR FITNESS FOR A PARTICULAR PURPOSE. BW SHALL NOT BE LIABLE FOR ANY SPECIAL, INDIRECT, INCIDENTAL, OR CONSEQUENTIAL DAMAGES OR LOSSES, INCLUDING LOSS OF DATA, WHETHER ARISING FROM BREACH OF WARRANTY OR BASED ON CONTRACT, TORT OR RELIANCE OR ANY OTHER THEORY.

Since some countries or states do not allow limitation of the term of an implied warranty, or exclusion or limitation of incidental or consequential damages, the limitations and exclusions of this warranty may not apply to every buyer. If any provision of this warranty is held invalid or unenforceable by a court of competent jurisdiction, such holding will not affect the validity or enforceability of any other provision.

GasAlertMicro 5 & GasAlertMicro 5 PID

Introduction

This quick reference guide provides basic information for the GasAlertMicro 5 and GasAlertMicro 5 PID. Refer to the user manual on the accompanying CD-ROM for complete operating instructions. The GasAlertMicro 5 and GasAlertMicro 5 PID gas detector (“the detector”) warns of hazardous gas at levels above user-selectable alarm setpoints.

The detector is a personal safety device. It is your responsibility to respond properly to the alarm.

Note

The detector is shipped with English as the displayed language. The Portuguese, Spanish, German, and French guides have their screenshots displayed in the corresponding language.

Safety Information - Read First

Use the detector only as specified in this guide, otherwise the protection provided by the detector may be impaired.

Read the following **Cautions** before using the detector.

Cautions

- ⇒ **Warning: Substitution of components may impair Intrinsic Safety.**
- ⇒ **Caution: For safety reasons, this equipment must be operated and serviced by qualified personnel only. Read and understand the user manual completely before operating or servicing.**
- ⇒ **Calibrate the detector before first-time use and then on a regular schedule, depending on use and sensor exposure to poisons and contaminants. BW recommends at least once every 180 days (6 months).**

- ⇒ It is recommended that the combustible sensor be checked with a known concentration of calibration gas after any known exposure to contaminants/poisons (sulfur compounds, silicon vapors, halogenated compounds, etc.).
- ⇒ BW recommends to “bump test” the sensors, before each day’s use, to confirm their ability to respond to gas by exposing the detector to a gas concentration that exceeds the alarm setpoints. Manually verify that the audible and visual alarms are activated. Calibrate if the readings are not within the specified limits.
- ⇒ Only the combustible gas detection portion of this instrument has been assessed for performance by CSA International.
- ⇒ The combustible sensor is factory calibrated to 50% LEL methane. If monitoring a different combustible gas in the % LEL range, calibrate the sensor using the appropriate gas.
- ⇒ Caution: High off-scale readings may indicate an explosive concentration.
- ⇒ Protect the combustible sensor from exposure to lead compounds, silicones, and chlorinated hydrocarbons. Although certain organic vapors (such as leaded gasoline and halogenated hydrocarbons) may temporarily inhibit sensor performance, in most cases, the

sensor will recover after calibration.

- ⇒ For use only in potentially explosive atmospheres where oxygen concentrations do not exceed 20.9% (v/v).
- ⇒ Any rapid up-scaling reading followed by a declining or erratic reading may indicate a gas concentration beyond upper scale limit, which may be hazardous.
- ⇒ Extended exposure of the GasAlertMicro 5 and GasAlertMicro 5 PID to certain concentrations of combustible gases and air may stress a detector element, which can seriously affect its performance. If an alarm occurs due to a high concentration of combustible gases, recalibration should be performed, or if needed, the sensor replaced.
- ⇒ Protect the PID sensor from exposure to silicone vapors.
- ⇒ The BW pump module (M5-PUMP) is certified for use with the GasAlertMicro 5 and GasAlertMicro 5 PID only.

**Parts of the GasAlertMicro 5 &
GasAlertMicro 5 PID**

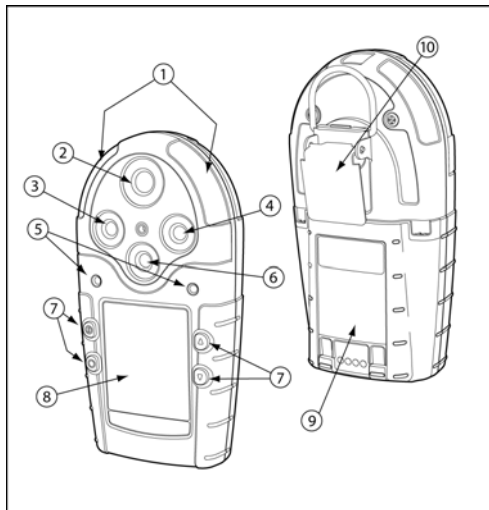





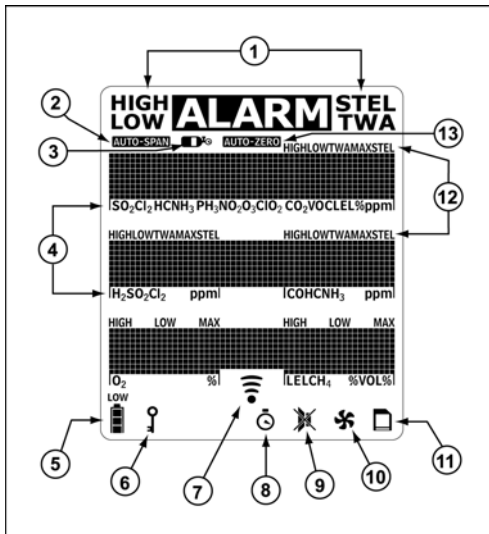











Item	Description
1	Visual alarm bars (LED)
2	Toxic 1/PID sensor
3	Toxic 2 sensor
4	LEL sensor
5	Audible alarms
6	Oxygen sensor
7	Pushbuttons
8	Display (LCD)
9	Battery pack
10	Alligator clip

Display Elements













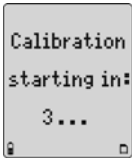



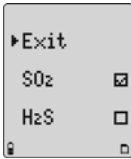
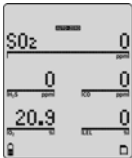

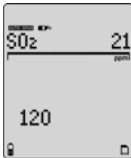

Item	Description
1	Alarm condition
2	Automatically span sensor
3	Gas cylinder
4	Gas identifier bars
5	Battery life indicator
6	Pass code lock
7	Data transmission
8	Clock
9	Stealth mode
10	Optional pump indicator
11	Optional datalogger card indicator
12	Alarm condition (low, high, TWA, STEL, or multi-gas) or view TWA, STEL, and maximum gas exposures (MAX)
13	Automatically zero sensor

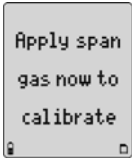
Pushbuttons

Pushbutton	Description
	<ul style="list-style-type: none"> ● To turn on the detector press . ● To turn off the detector, press and hold  until the countdown is complete.
	<ul style="list-style-type: none"> ● To increment the displayed value or scroll up, press . ● To enter the user options menu, press  and  simultaneously and hold until the countdown is complete. ● To clear the TWA, STEL, and maximum (MAX) gas exposure readings, press  and  simultaneously and hold until the countdown is complete. ● To view the date and time, alarm setpoints (TWA, STEL, low, and high) of all the sensors, and the LEL/PID correction factor (if applicable), press .
	<ul style="list-style-type: none"> ● To decrement the displayed value or scroll down, press . ● To initiate calibration and setting alarm setpoints, press  and  simultaneously and hold until the countdown is complete.
	<ul style="list-style-type: none"> ● To view the TWA, STEL, and maximum (MAX) hold readings, press . ● To acknowledge latched alarms press .

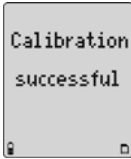
Calibration

Procedure	Display	Procedure	Display
1. In a clean atmosphere, press and hold  and  simultaneously (as the detector beeps and flashes to the corresponding countdown) to enter calibration. The detector then reads Starting calibration.		4. This option allows the user to select which sensor to span. Use  and  to scroll to a sensor and press  to deselect it. Sensors should be spanned in the following order: exotics (NH ₃ , ClO ₂ , O ₃ , and Cl ₂), single gas, quad gas (H ₂ S, CO, O ₂ , and LEL), and lastly PID.	
2. AUTO-ZERO flashes while the detector zeroes all of the sensors and calibrates the oxygen sensor. If a sensor failed to auto zero, it will bypass the span.		5. Attach the calibration cap and apply gas at a flow rate of 500 ml/min.  flashes as the unit senses which gas is being applied. After 30 seconds, AUTO-SPAN flashes and a countdown appears while the unit completes the span.	
3. Next, the following three screens appear: - Apply span gas now to calibrate - or press  to select sensor(s) - or press  to skip calibration If no button is pressed, proceed to step #5. If  is pressed, go to step #4. If  is pressed, go to the end of step #6.		6. Once the span is complete, the following three screens appear: - Calibration successful - Press  to apply a new cal gas - Press  to end span Repeat steps #3-6 to calibrate the remaining sensors. The display then advises to press  to set or  to bypass the calibration due dates.	

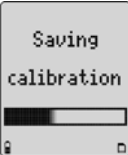
Procedure	Display
<p>7. Press \blacktriangledown or \blacktriangle to change the calibration due date. Press \bigcirc to accept this value and proceed to the next due date. (If a sensor failed or did not span, you cannot change the calibration due date for that sensor.)</p> <p>The display then advises to press \bigcirc to set or $\textcircled{+}$ to bypass the alarm setpoints.</p>	
<p>8. Press \blacktriangledown or \blacktriangle to change the alarm setpoint. Press \bigcirc to save the displayed value and proceed to the next setpoint. Set the remaining setpoints. The detector beeps twice at the end of the alarm setpoint stage.</p>	
<p>9. Saving calibration displays to indicate that calibration is complete.</p> <p><i>Note</i></p> <p><i>The calibration cap should only be used during the calibration process.</i></p>	

Attach the Gas Cylinder to the Detector



If an O_3 or ClO_2 sensor is located in the Toxic 2 sensor position, a single gas calibration cap must be used.

For complete information and procedures, refer to the *GasAlertMicro 5/PID/IR User Manual*.

Alarms



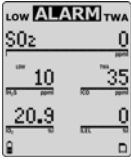
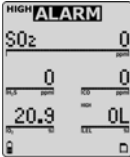
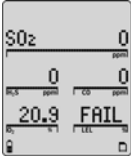
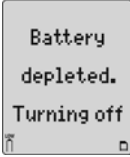
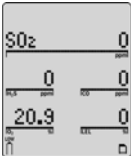
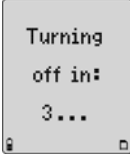

The following table lists the numerous alarms of the detector.

Alarm	Display	Alarm	Display
Low Alarm: <ul style="list-style-type: none"> • Fast beep • Slow flash • ALARM and target gas bar flash • Vibrator alarm activates 		TWA Alarm: <ul style="list-style-type: none"> • Fast beep • Slow flash • ALARM and target gas bar flash • Vibrator alarm activates 	
High Alarm: <ul style="list-style-type: none"> • Constant beep • Fast flash • ALARM and target gas bar flash • Vibrator alarm activates 		STEL Alarm: <ul style="list-style-type: none"> • Constant beep • Fast flash • ALARM and target gas bar flash • Vibrator alarm activates 	

Alarm	Display	Alarm	Display
<p>Multi-Gas Alarm:</p> <ul style="list-style-type: none"> • Alternating low and high alarm beep and flash • ALARM and target gas bars flash • Vibrator alarm activates 	 <p>The display shows 'LOW ALARM TWA' at the top. Below, it displays 'SO2 0' with a target bar at 10 ppm. To the right, it shows 'CO 35' with a target bar at 35 ppm. At the bottom, it shows '20.9' and '0' with their respective target bars.</p>	<p>Over Range Alarm: (Over Level Exposure)</p> <ul style="list-style-type: none"> • Fast beep and flash • ALARM and target gas bar flash • Vibrator alarm activates 	 <p>The display shows 'HIGH ALARM' at the top. Below, it displays 'SO2 0' with a target bar at 0 ppm. To the right, it shows 'CO 0' with a target bar at 0 ppm. At the bottom, it shows '20.9' and '0L' with their respective target bars.</p>
<p>Sensor Alarm:</p> <ul style="list-style-type: none"> • One beep every 15 seconds • FAIL flashes above the failed sensor 	 <p>The display shows 'SO2 0' with a target bar at 0 ppm. To the right, it shows 'CO 0' with a target bar at 0 ppm. At the bottom, it shows '20.9' and 'FAIL' with their respective target bars.</p>	<p>Automatic Shutdown Alarm:</p> <ul style="list-style-type: none"> • Eight beeps and flashes • Vibrator alarm temporarily activates 	 <p>The display shows the text: 'Battery depleted. Turning off'.</p>
<p>Low Battery Alarm:</p> <ul style="list-style-type: none"> • One beep and two flashes every 25 seconds • LOW flashes 	 <p>The display shows 'SO2 0' with a target bar at 0 ppm. To the right, it shows 'CO 0' with a target bar at 0 ppm. At the bottom, it shows '20.9' and '0' with their respective target bars. A 'LOW' indicator is visible at the bottom left.</p>	<p>Normal Shutdown:</p> <ul style="list-style-type: none"> • Three beeps and flashes 	 <p>The display shows the text: 'Turning off in: 3...'.</p>

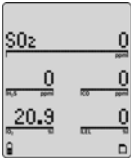
GasAlertMicro 5 & GasAlertMicro 5 PID

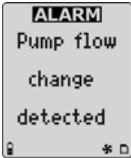
Quick Reference Guide

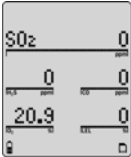
Alarm	Display	Alarm	Display
<p>Confidence Beep:</p> <ul style="list-style-type: none">One beep, one flash, and one vibrate every 10 seconds		<p>Pump Alarm:</p> <ul style="list-style-type: none">Screen flashes:<ul style="list-style-type: none">Pump flow change detectedCheck for blocked inletor press  to run a pump testTwo fast beeps and alternating flashesVibrator alarm activatesALARM and  icons flash	
<p>MMC Fail Alarm:</p> <ul style="list-style-type: none">One beep every 5 seconds icon flashes			

Note

Alarms can be set to be latching or non-latching. To confirm this setting, access the latching alarm option in the user options menu.

If the detector is in stealth mode, it only vibrates in alarm mode (the audible and visual alarms are disabled).

User Options Menu

To access the user options menu press and hold ▲ and ▼ until the detector completes the countdown.

To scroll through the options, press ▼ or ▲. Press ○ to select the option. The following are the available user options:

1. **Exit:** Exits the user options menu.
2. **Options:**
 - **Backlight:** Enables the automatic backlight in low-light conditions;
 - **Confibeep:** Enables/disables the confidence beep;
 - **Due-lock:** Upon start-up, it prevents the user from operating a detector that is overdue for calibration by requesting a pass code;
 - **Latch:** This option allows an alarm to remain active until the user acknowledges the alarm;
 - **Passcode:** Prevents unauthorized personnel from having access to the user options menu, calibration function, and alarm setpoint adjust function;
3. **Sensors:**
 - **Safe:** Enables the display to read **Safe** if the detector does not enter an alarm;
 - **Fast pump:** Maximizes the pump speed if the sampling hose is longer than 50 ft. (15.24 m).

Note

Maximizing the pump speed will reduce the battery life.

- **Sens on:** Enables/disables the sensor (the detector still operates if a sensor is disabled);
- **Span gas:** Changes the span gas concentration for each sensor;
- **STEL period:** Changes the short-term exposure limit (5-15 minutes; applicable to toxic sensors only);
- **TWA method:** Choose either the OSHA or ACGIH standard of calculating the time-weighted average;
- **Resolution:** Sets the resolution of the gas measurement as either regular or extra (if applicable);

- **%vol CH₄**: Shows the LEL reading in % vol. assuming a methane environment;
- **Correction**: Allows the user to adjust the instrument reading for a specific gas (only applicable to LEL and PID sensors);
- **Autocal**: Automatic oxygen calibration upon start-up.

4. **Logger**: Allows the user to change the datalogging interval (between 1-127 seconds).
5. **Clock**: Allows the user to set the date and time for the detector.
6. **Language**: Enables the display's language in the user's choice of English, French, Spanish, German, or Portuguese.

Maintenance

To keep the detector in good operating condition, perform the following basic maintenance as required:

- Calibrate, bump check, and inspect the detector at regular intervals.
- Keep an operations log of all maintenance, bump checks, calibrations, and alarm events.
- Clean the exterior with a soft damp cloth. Do not use solvents, soaps, or polishes.
- Do not immerse the detector in liquids.

Replacing the Batteries

⚠ Warning: Always turn off the detector before removing the battery pack.

The battery packs are hot-swappable, but alkaline batteries inside the pack must be changed in a non-hazardous atmosphere.

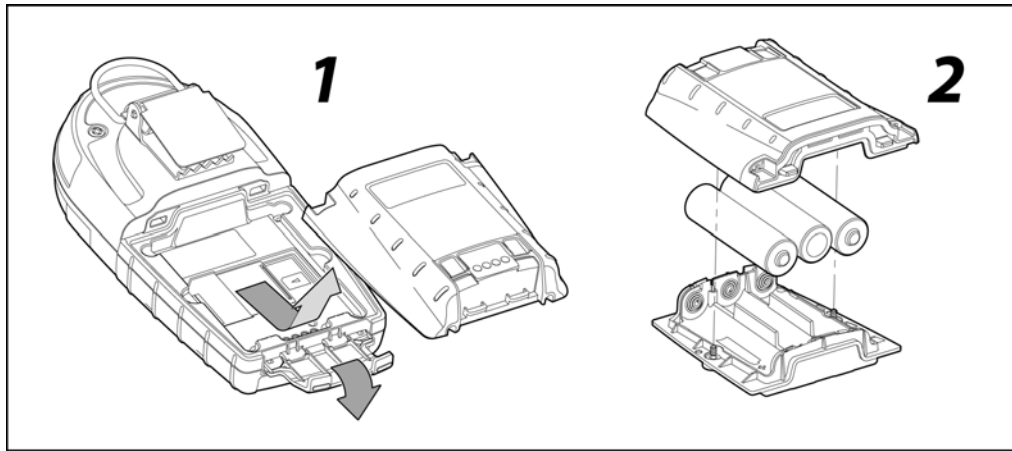

1. Open the latch on the bottom of the detector and remove the battery pack by lifting up the end of the pack.
2. Unscrew the two captive screws on the battery pack, open the pack, and replace the three alkaline batteries.
3. Replace the shell and screw the battery pack back together.
4. Insert the battery pack back into place and secure the latch.

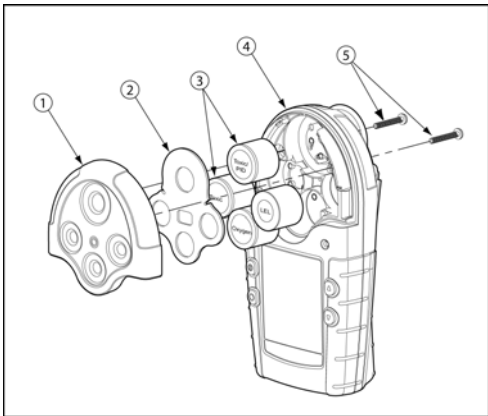
Replacing a Sensor or Sensor Filter

Item	Description
1	Sensor cover
2	Sensor filter
3	Sensors
4	Detector
5	Machine screws (2)

Specifications

Instrument dimensions: 14.5 x 7.4 x 3.8 cm
(5.7 x 2.9 x 1.5 in.)

Weight: 370 g (13.1 oz.)

Operating and storage conditions**Temperature:**

VOC: -10°C to +40°C (14°F to +104°F)

Other gases: -20°C to +50°C (-4°F to +122°F)

Humidity:

O₂: 0% to 99% relative humidity (non-condensing)

VOC: 0% to 95% relative humidity (non-condensing)

Combustibles: 5% to 95% relative humidity (non-condensing)

Cl₂: 10% to 95% relative humidity (non-condensing)

HCN, ClO₂: 15% to 95% relative humidity (non-condensing)

Other gases: 15% to 90% relative humidity (non-condensing)

Pressure: 95 to 110 kPa

Alarm setpoints: May vary by region and are user-settable

Detection range:

O₂: 0 – 30.0% vol. (0.1% vol. increments)
CO: 0 – 999 ppm (1 ppm increments)
CO (TwinTox sensor): 0 – 500 ppm (1 ppm increments)
H₂S: 0 – 500 ppm (1 ppm increments)
H₂S (TwinTox sensor): 0 – 500 ppm (1 ppm increments)
Combustibles: 0 – 100% LEL (1% LEL increments) or
0 – 5.0% v/v methane
PH₃: 0 – 5.0 ppm (0.1 ppm increments)
SO₂: 0 – 150 ppm (1 ppm increments)
Cl₂: 0 – 50.0 ppm (0.1 ppm increments)
NH₃: 0 – 100 ppm (1 ppm increments)
NO₂: 0 – 99.9 ppm (0.1 ppm increments)
HCN: 0 – 30.0 ppm (0.1 ppm increments)
ClO₂: 0 – 1.00 ppm (0.01 ppm increments)
O₃: 0 – 1.00 ppm (0.01 ppm increments)
VOC: 0 – 1000 ppm (1.0 ppm increments)

Sensor type:

H₂S/CO: Twin plug-in electrochemical cell
Combustibles: Plug-in catalytic bead
VOC: Photoionization detector (PID)
Other gases: Single plug-in electrochemical cell

O₂ measuring principle: Capillary controlled concentration sensor

Alarm conditions: TWA alarm, STEL alarm, low alarm, high alarm, multi-gas alarm, over range alarm, sensor alarm, pump alarm, MMC fail alarm, low battery alarm, confidence beep, automatic shutdown alarm

Audible alarm: 95 dB at 1 ft. (0.3 m) variable pulsed dual beepers

Visual alarm: Dual red light-emitting diodes (LED)

Display: Alphanumeric liquid crystal display (LCD)

Backlight: Automatically activates whenever there is insufficient light to view the display (if enabled) and during alarm conditions

Self-test: Initiated at activation

Calibration: Automatic zero and automatic span

Oxygen sensor: Automatic span on activation (selectable)

User field options: Confidence beep, latching low and high alarms, pass code protection, enable/disable safe display mode, enable/disable fast pump, combustible sensor measurement, sensor disable, TWA and STEL, language selection, enable/disable automatic oxygen calibration, set span concentration values, set STEL calculation period, set TWA method, gas measurement resolution, enable/disable automatic backlight, adjust clock calendar, and set logging rate (datalogger models only).

Datalogger units: Contact [BW Technologies](#) for a list of approved MMC or SD cards.

Battery operating time

Toxic, O₂, and LEL sensors: 20 hours (three alkaline cells or one rechargeable battery pack)

Toxic, O₂, LEL, and PID sensors: 10 hours (three alkaline cells or one rechargeable battery pack)

GasAlertMicro 5 & GasAlertMicro 5 PID

Quick Reference Guide

Approved batteries

Approved batteries for product (standards IEC 60079-11, EN50020, UL913, C22.2 No. 157)

Alkaline:		Temperature Code
Duracell MN1500	-20°C ≤ Ta ≤ 50°C	T3C (139.8°C)
	-20°C ≤ Ta ≤ 40°C	T4 (129.8°C)
Energizer E91	-20°C ≤ Ta ≤ 50°C	T3B (163°C)
	-20°C ≤ Ta ≤ 40°C	T3C (153°C)

NiMH rechargeable:		
M5-BAT01	-20°C ≤ Ta ≤ 50°C	T4

Battery charger: GasAlertMicro 5 battery charger

First-time charge: 4 hours per battery pack

Normal charge: 3-4 hours per battery pack

Warranty: 2 years including sensors (1 year NH₃ sensor and PID lamp)

Approvals

Approved by CSA to both U.S. and Canadian Standards

Approved: Class I, Division 1, Group A, B, C, and D; Class I, Zone 0, Group IIC

Standards: CAN/CSA C22.2 No. 157 and C22.2 152
ANSI/UL – 913 and ANSI/ISA – S12.13 Part 1

ATEX: CE 0539  II 1 G EEx ia IIC
KEMA 05ATEX 1096X

IECEX: Ex ia IIC

ABS Type Approved: VA-348169-X

This equipment has been tested and found to comply with the limits for a Class B digital device, pursuant to Part 15 of the FCC Rules and ICES-003 Canadian EMI requirements. These limits are designed to provide reasonable protection against harmful interference in a residential installation. This equipment generates, uses and can radiate radio frequency energy and, if not installed and used in accordance with the instructions, may cause harmful interference to radio communications. However, there is no guarantee that interference will not occur in a particular installation. If this equipment does cause harmful interference to radio or television reception, which can be determined by turning the equipment off and on, the user is encouraged to try to correct the interference by one or more of the following measures:

- Reorient or relocate the receiving antenna.
- Increase the separation between the equipment and receiver.
- Connect the equipment into an outlet on a circuit different from that to which the receiver is connected.
- Consult the dealer or an experienced radio/TV technician for help.



D5614/6 English

iERP: 123020

© 2006 BW Technologies. All rights reserved. Printed in Canada.

All product names are trademarks of their respective companies.





Thank you for reading this data sheet.

For pricing or for further information, please contact us at our UK Office, using the details below.



UK Office

Keison Products,

P.O. Box 2124, Chelmsford, Essex, CM1 3UP, England.

Tel: +44 (0)330 088 0560

Fax: +44 (0)1245 808399

Email: sales@keison.co.uk

Please note - Product designs and specifications are subject to change without notice. The user is responsible for determining the suitability of this product.