



**Tecal 140S
Calibrator
Operator's Manual**

Issue 4

Date of issue:

3rd May 2005

Techne is a trademark

© Techne, 2003

CONTENTS**Tecal 140S Calibrator Operator's Manual**

	<i>page</i>
SAFETY AND INSTALLATION	
English	4
Français	5
Deutsch	6
Español	7
THE CALIBRATOR	8
Applications	8
Warning	8
Specification	9
Working Conditions	9
Packing	9
WHEN YOU SWITCH ON	10
Front Panel controls	10
Setting the Units for Temperature	12
Setting the Operating Temperature	12
Water Cooling	12
After Use	12
RS232 SERIAL INTERFACE	13
Sending data to the PC (Auto Control)	13
TECHNICAL INFORMATION	14
General advice	14
General Fault finding	14
Replacement parts	15
Accessories	15
Inserts	16

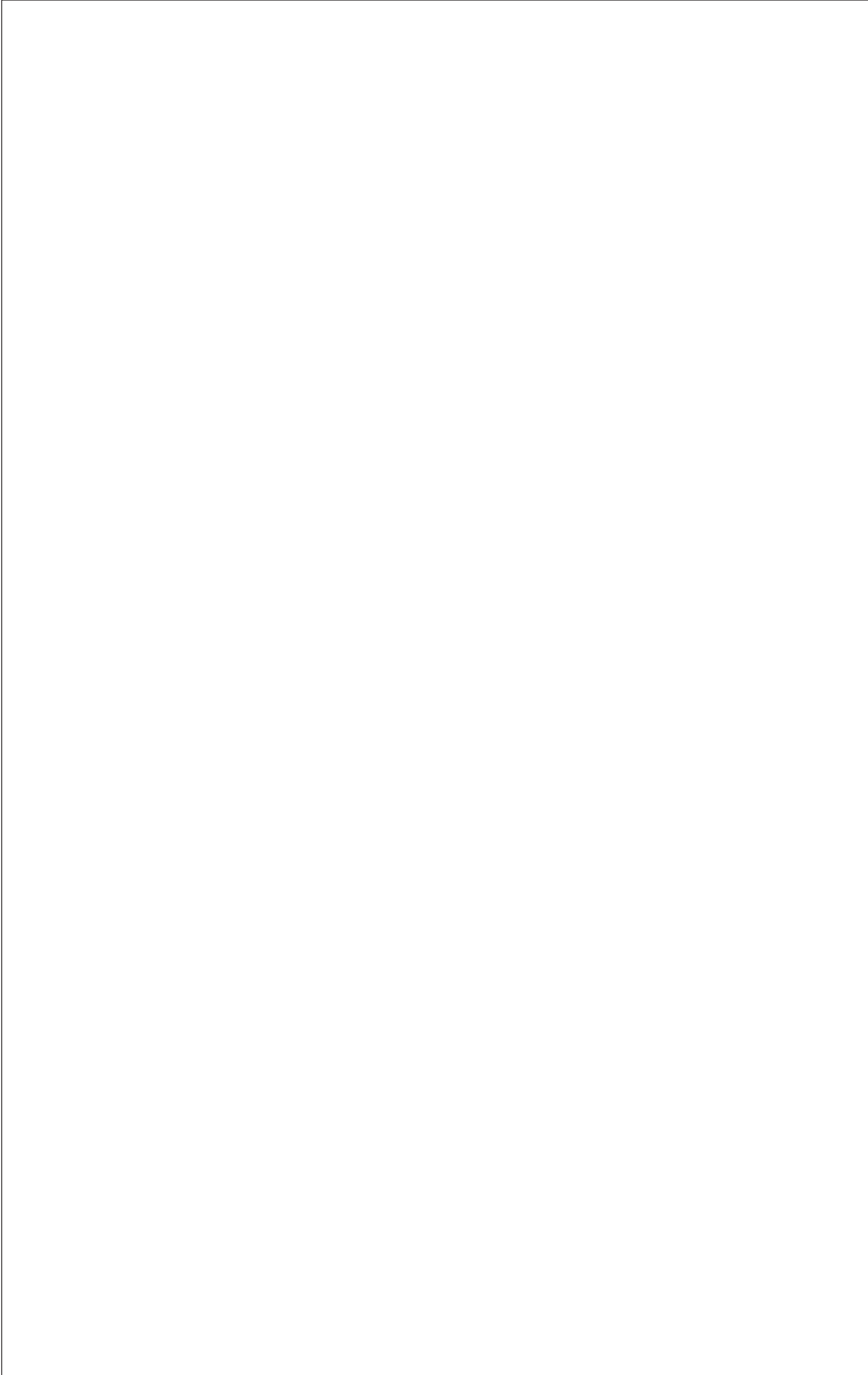

NOTES

Introduction

Please read all the information in this booklet before using the unit.

Warning

HIGH TEMPERATURES ARE DANGEROUS: they can cause serious burns to operators and ignite combustible material.

Techne have taken great care in the design of these units to protect operators from hazards, but users should pay attention to the following points:

- USE CARE AND WEAR PROTECTIVE GLOVES TO PROTECT HANDS;
- DO NOT put hot objects on or near combustible objects;
- DO NOT operate the unit close to inflammable liquids or gases;
- DO NOT place any liquid directly in your unit;
- At all times USE COMMON SENSE.

Operator Safety

All users of Techne equipment must have available the relevant literature needed to ensure their safety.

It is important that only suitably trained personnel operate this equipment, in accordance with the instructions contained in this manual and with general safety standards and procedures. If the equipment is used in a manner not specified by Techne the protection provided by the equipment to the user may be impaired.

All Techne units have been designed to conform to international safety requirements and are fitted with an overtemperature cutout. On some models, the cutout is adjustable and should be set to suit the application. On all other models the cutout is preset to protect the unit.

If a safety problem should be encountered, switch off at the mains socket and remove the plug from the supply.

Installation

1. All Techne units are supplied with a power cable. This may be integral or plug-in.
2. Before connecting the mains supply, check the voltage against the rating plate. Connect the mains cable to a suitable plug according to the table below. **Note that the unit must be earthed to ensure proper electrical safety.**

Connections	220/240V	110/120V
Live	Brown	Black
Neutral	Blue	White
Earth	Green/yellow	Green

The fused plug supplied with the mains lead for use in the UK is fitted with the following value fuse to protect the cable:

230V UK 10 AMP

The fuse in the unit protects the unit and the operator. Note that units marked 230V on the rating plate work at 220V; units marked 120V work at 110V. In both cases, however, the heating rate will degrade by approximately 8%. The rating plate is on the rear of the unit.

3. Plug the mains cable into the socket on the rear of the unit.
4. Place the unit on a suitable bench or flat workspace, or in a fume cupboard if required, ensuring that the air inlet vents on the underside are free from obstruction.
5. Note that the following symbols may be next to the indicator lamps on the front panel of the units and have the following meanings:

~ : the power indicator

⚡ : the heater indicator

🔥 : the overtemperature indicator

6. Symbols on or near the power switch of the unit have the following meanings:

I : mains switch On

O : mains switch Off

After use

When you have finished heating samples, remember that parts of the unit – the tubes, blocks and associated accessories – may be very hot. Take the precautions listed earlier.

Guarantee

The unit is guaranteed against any defect in material or workmanship for the period specified on the enclosed guarantee card. This period is from the date of purchase, and within this period all defective parts will be replaced free of charge provided that the defect is not the result of misuse, accident or negligence. Servicing under this guarantee should be obtained from the supplier.

Notwithstanding the description and specification(s) of the units contained in the Operator's Manual, Techne hereby reserves the right to make such changes as it sees fit to the units or to any component of the units.

This Manual has been prepared solely for the convenience of Techne customers and nothing in this Instruction Book shall be taken as a warranty, condition or representation concerning the description, merchantability, fitness for purpose or otherwise of the units or components.

User maintenance

NOTE THAT THIS EQUIPMENT SHOULD ONLY BE DISMANTLED BY PROPERLY TRAINED PERSONNEL. REMOVING THE SIDE, FRONT OR REAR PANELS EXPOSES POTENTIALLY LETHAL MAINS VOLTAGES. THERE ARE NO USER MAINTAINABLE PARTS WITHIN THE EQUIPMENT.

In the unlikely event that you experience any problems with your unit which cannot easily be remedied, you should contact your supplier and return the unit if necessary. Please include any details of the fault observed and remember to return the unit in its original packing. Techne accept no responsibility for damage to units which are not properly packed for shipping: if in doubt, contact your supplier. See the Decontamination Certificate supplied with your unit.

1. Cleaning

Before cleaning your unit ALWAYS disconnect from the power supply and allow to cool below 50° C.

Your unit can be cleaned by wiping with a damp soapy cloth. Care should be exercised to prevent water from running inside the unit. Do not use abrasive cleaners.

2. Fuses

Your unit is protected by one or two fuses. These should only be changed by suitably qualified personnel. If the fuses blow persistently, a serious fault is indicated and you may need to return the unit to your supplier for repair.

Introduction

Veuillez lire attentivement toutes les instructions de ce document avant d'utiliser l'appareil.

Avertissement

DANGER DE TEMPERATURES ELEVEES : les opérateurs peuvent subir de graves brûlures et les matériaux combustibles risquent de prendre feu.

Techne a apporté un soin tout particulier à la conception de ces appareils de façon à assurer une protection maximale des opérateurs, mais il est recommandé aux utilisateurs de porter une attention spéciale aux points suivants :

- **PROCEDER AVEC SOIN ET PORTER DES GANTS POUR SE PROTEGER LES MAINS.**
- **NE PAS** poser d'objets chauds sur ou près de matériaux combustibles.
- **NE PAS** utiliser l'appareil à proximité de liquides ou de gaz inflammables.
- **NE PAS** verser de liquide directement dans l'appareil.
- **FAIRE TOUJOURS PREUVE DE BON SENS.**

Sécurité de l'opérateur

Tous les utilisateurs de produits Techne doivent avoir pris connaissance des manuels et instructions nécessaires à la garantie de leur sécurité.

Important : cet appareil doit impérativement être manipulé par un personnel qualifié et utilisé selon les instructions données dans ce document, en accord avec les normes et procédures de sécurité générales. Dans le cas où cet appareil ne serait pas utilisé selon les consignes précisées par Techne, la protection pour l'utilisateur ne serait alors plus garantie.

Tous les appareils Techne sont conçus pour répondre aux normes de sécurité internationales et sont dotés d'un coupe-circuit en cas d'excès de température. Sur certains modèles, ce coupe-circuit est réglable pour s'adapter à l'application désirée. Sur d'autres modèles, il est pré-réglée en usine pour assurer la protection de l'appareil. Dans le cas d'un problème de sécurité, coupez l'alimentation électrique au niveau de la prise murale et enlevez la prise connectée à l'appareil.

Installation

1. Tous les appareils Techne sont livrés avec un câble d'alimentation qui peut être intégré à l'appareil ou à raccorder.

2. Avant de brancher l'appareil, vérifiez la tension requise indiquée sur la plaque d'identification. Raccordez le câble électrique à la prise appropriée en vous reportant au tableau ci-dessous. **Il est important que l'appareil soit relié à la terre pour assurer la protection électrique requise.**

Connexions	220/240 V	110/120 V
Phase	Marron	Noir
Neutre	Blue	Blanc
Terre	Vert/juane	Vert

Le fusible à l'intérieur de l'appareil est destiné à assurer la protection de l'appareil et de l'opérateur.

Remarque : les appareils dont la plaque indique 230 V peuvent fonctionner sur 220 V, et ceux dont la plaque indique 120 V peuvent fonctionner sur 110 V. Dans les deux cas cependant, la capacité de chauffage diminuera d'environ 8 %. La plaque d'identification se trouve à l'arrière de l'appareil.

3. Raccordez le câble d'alimentation à la prise située à l'arrière de l'appareil.

4. Placez l'appareil sur un plan de travail ou surface plane, ou le cas échéant, dans une hotte d'aspiration, en s'assurant que les trous d'aération situés sous l'appareil ne sont pas obstrués.

5. Les symboles ci-dessous situés à côté des témoins lumineux sur la face avant de l'appareil ont la signification suivante :

~ : témoin d'alimentation

☰ : témoin de chauffage

⚡ : témoin d'excès de température

6. Les symboles situés sur ou à côté de l'interrupteur de l'appareil ont la signification suivante :

○ : arrêt

I : marche

Après utilisation

Lorsque vous avez fini de chauffer les échantillons, n'oubliez pas que certaines parties de l'appareil - les éprouvettes, leurs supports et autres accessoires - risquent d'être très chaudes. Il est donc recommandé de toujours prendre les précautions citées plus haut.

Garantie

L'appareil est garanti contre tout défaut ou vice de fabrication pour la durée figurant sur la carte de garantie, à compter de la date d'achat de l'appareil. Au cours de cette période, toutes les pièces défectueuses seront remplacées gratuitement, dans la mesure où la défaillance n'est pas due à une mauvaise utilisation, un accident ou une négligence. Toute réparation sous garantie sera effectuée par le fournisseur.

Malgré la description et les spécifications de l'appareil données dans le manuel de l'utilisateur, Techne se réserve le droit d'effectuer les changements nécessaires à l'appareil ou à tout élément qui entre dans sa composition.

Ce manuel a été exclusivement rédigé à l'attention des clients de Techne, et aucun élément de ce guide d'instructions ne peut être utilisé comme garantie, condition ou représentation concernant la description, commercialisation, adaptation aux conditions d'utilisation ou autre des appareils ou de leurs composants.

Entretien utilisateur

IMPORTANT : CET APPAREIL NE PEUT ETRE DEMONTE QUE PAR DU PERSONNEL QUALIFIE. LORSQUE LES PANNEAUX AVANT, ARRIERE ET LATERAUX SONT DEMONTES, L'OPERATEUR EST EXPOSE A DES TENSIONS QUI PEUVENT ETRE MORTELLES.

CET APPAREIL NE CONTIENT AUCUN ELEMENT QUI DEMANDE UN ENTRETIEN DE LA PART DE L'UTILISATEUR.

Dans le cas peu probable où votre appareil présente un défaut de fonctionnement auquel il est difficile de remédier, il est alors préférable de contacter votre fournisseur et, le cas échéant, de renvoyer le matériel. Veuillez inclure une description détaillée du problème constaté et retourner l'appareil dans son emballage d'origine. Techne ne sera pas tenu responsable des dommages subis par tout appareil dont l'emballage est inadéquat pour le transport. Pour plus de sûreté, contactez votre fournisseur. Voir le certificat de décontamination livré avec le produit.

1. Nettoyage

Avant de nettoyer l'appareil, assurez-vous TOUJOURS que le câble d'alimentation est déconnecté et laissez la température redescendre en dessous de 50 °C. Utilisez un chiffon imprégné d'eau savonneuse pour nettoyer l'appareil. Veillez à ne pas introduire d'eau dans l'appareil. N'utilisez pas de produits abrasifs.

2. Fusibles

La protection de l'appareil est assurée par un ou deux fusibles dont le remplacement ne peut être effectué que par un personnel qualifié.

Si les fusibles sautent sans arrêt, il s'agit d'un problème sérieux. Nous vous conseillons dans ce cas de prendre contact avec votre fournisseur pour réparation.

Einleitung

Bitte lesen Sie diese Bedienungsanleitung komplett bevor Sie dieses Gerät benutzen.

Warnung

HOHE TEMPERATUREN SIND GEFÄHRLICH: sie können dem Bediener ernsthafte Verletzungen zufügen und brennbare Materialien können sich leicht entzünden.

Techne hat bei der Konstruktion dieses Gerätes sehr darauf geachtet, daß der Bediener vor Gefahren geschützt ist. Dennoch sollten Sie auf die folgenden Punkte achten:

- SEIEN SIE VORSICHTIG UND TRAGEN SIE SCHUTZHANDSCHUHE
- Legen Sie heiße Gegenstände NICHT auf oder in die Nähe von leicht brennbaren Materialien; vermeiden Sie Arbeiten in der Nähe von leicht entzündbaren Flüssigkeiten oder Gasen.
- Bringen sie KEINE Flüssigkeiten direkt in Ihr Gerät.
- Benutzen Sie immer den normalen Menschenverstand

Sicherheit des Anwenders

Alle Benutzer von Techne Geräten müssen Zugang zu der entsprechenden Literatur haben, um ihre Sicherheit zu gewähren.

Es ist wichtig, daß diese Geräte nur von entsprechend geschultem Personal betrieben werden, das die in dieser Gebrauchsanweisung enthaltenen Maßnahmen und allgemeine Sicherheitsbestimmungen und -vorkehrungen beachtet. Wenn das Gerät anders eingesetzt wird als vom Hersteller empfohlen, kann dies die persönliche Sicherheit des Anwenders beeinträchtigen. Die Geräte von Techne entsprechen den internationalen Sicherheitsbestimmungen und sind mit einem automatischen Übertemperaturabschalter ausgestattet. Bei einigen Modellen ist der Übertemperaturabschalter verstellbar und sollte je nach Anwendung entsprechend eingestellt werden. Bei allen anderen Modellen ist der Temperaturschutz voreingestellt um Schäden am Gerät zu vermeiden. Wenn ein Sicherheitsproblem auftreten sollte, muß das Gerät ausgeschaltet und vom Stromnetz getrennt werden.



Installation

1. Alle Techne Geräte werden mit einem Stromanschluskabel geliefert. Dieses ist entweder fest mit dem Gerät verbunden oder zum Einstecken.
2. Vergleichen Sie, ob die Spannung Ihrer Stromversorgung mit den Angaben auf dem Typenschild des Gerätes übereinstimmen. Verbinden Sie das Stromanschluskabel mit einer geeigneten Stromversorgung gemäß der nachstehenden Tabelle.
Achtung: Das Gerät muß geerdet sein, um die elektrische Sicherheit zu gewährleisten!

<i>Verbindungen</i>	<i>220/240V</i>	<i>110/120V</i>
Stromführend	Braun	Schwarz
Neutral	Blau	Weiß
Erde	Grün/Gelb	Grün

Geräte, die für 230 Volt ausgelegt sind, können auch bei 220 Volt arbeiten. Geräte für 120 Volt auch bei 110 Volt. In beiden Fällen verringert sich die Aufheizrate um ca. 8%. Das Typenschild befindet sich hinten am Gerät.

3. Stecken Sie das Stromkabel in die vorgesehene Buchse hinten am Gerät.
4. Stellen Sie das Gerät auf eine ebene Arbeitsfläche bzw. (falls erforderlich) unter einen Laborabzug. Beachten Sie, daß die Entlüftungsrippen an der Geräteunterseite immer frei zugänglich sind.
5. Wenn die Anzeigenlämpchen an der Vorderseite leuchten, hat dies folgende Bedeutung:

- ~ : Gerät ist eingeschaltet
 : Gerät heizt
 : Übertemperaturschutz ist ausgelöst

6. Die Symbole auf oder neben dem EIN/AUS-Schalter an der Geräterückseite bedeuten:

- I : An
 O : Aus

Nach dem Gebrauch

Vergessen Sie nicht, daß Teile des Gerätes (die Gefäße, die Blöcke und andere Zubehörteile) nach dem Erhitzen von Proben noch sehr heiß sein können. Bitte beachten Sie die oben genannten Vorsichtsmaßnahmen.

Garantie

Die Garantiedauer des Gerätes ist auf der beiliegenden Garantiekarte angegeben und schließt Fehler im Material oder der Verarbeitung ein. Die Garantiedauer beginnt am Tag des Einkaufs. Sämtliche defekte Teile werden innerhalb dieses Zeitraumes kostenlos ersetzt unter der Voraussetzung, daß dem Defekt keine unsachgemäße Handhabung, Fahrlässigkeit oder ein Unfall zugrundeliegt. Der unter diese Garantie fallende Service wird vom Lieferanten geleistet.

Ungeachtet der in dieser Gebrauchsanweisung enthaltenen Beschreibungen und Spezifikationen, behält sich Techne hiermit das Recht vor, Änderungen an den Geräten bzw. an einzelnen Geräteteilen durchzuführen.

Diese Gebrauchsanweisung wurde ausschließlich dazu erstellt, um Kunden die Handhabung der Techne-Geräte zu erleichtern. Nichts in dieser Gebrauchsanweisung darf als Garantie, Bedingung oder Voraussetzung verstanden werden, sei es die Beschreibung, Marktgängigkeit, Zweckdienlichkeit oder sonstiges bezüglich der Geräte oder deren Bestandteile.

Wartung durch den Bediener

BEACHTEN SIE, DASS DIESES GERÄT NUR VON TECHNISCHEN FACHKRÄFTEN GEÖFFNET UND DEMONTIERT WERDEN DARF.

DURCH ENTFERNEN DES GEHÄUSES ODER GEHÄUSETEILEN SIND BAUTEILE MIT LEBENGEFÄHRLICHEN SPANNUNGEN FREI ZUGÄNGLICH.

IM INNERN DES GERÄTES BEFINDEN SICH KEINE TEILE, DIE VOM ANWENDER GEWARTET WERDEN MÜSSEN.

Falls Ihr Gerät nicht ordnungsgemäß arbeitet, wenden Sie sich an Ihren Lieferanten oder senden Sie das Gerät wenn nötig zurück. Fügen Sie eine genaue Beschreibung des Defektes bei. Verpacken Sie das Gerät möglichst im Originalkarton. Bitte beachten Sie, daß Techne und thermo-DUX keine Haftung bei Transportschäden aufgrund unzureichender Verpackung übernehmen. Setzen Sie sich im Zweifelsfall mit Ihrem Lieferanten in Verbindung. Bitte beachten Sie die Entgiftungsbescheinigung, die Sie mit dem Gerät erhalten haben.

1. Reinigen

Bevor Sie Ihr Gerät reinigen, sollten Sie

- zuerst den Netzstecker ziehen
- das Gerät unter 50°C abkühlen lassen.

Ein feuchtes Tuch mit Seifenlösung reinigt Ihr Gerät am besten. Achten Sie darauf, daß kein Wasser in das Gerät gelangt. Verwenden Sie keine Scheuermittel.

2. Sicherungen

Die Stromzuleitung ist durch ein oder zwei Sicherungen geschützt. Diese sollten nur durch qualifiziertes Fachpersonal ausgetauscht werden. Wenn die Sicherung wiederholt durchbrennt, liegt ein größerer Defekt vor. Das Gerät muß zur Reparatur an Ihren Lieferanten eingesandt werden.

Introducción

Le rogamos lea cuidadosamente la información contenida en este folleto antes de manipular el aparato.

Aviso

LAS TEMPERATURAS ELEVADAS SON PELIGROSAS: pueden causarle graves quemaduras y provocar fuego en materiales combustibles.

Techne ha puesto gran cuidado en el diseño de estos aparatos para proteger al usuario de cualquier peligro; aún así se deberá prestar atención a los siguientes puntos:

- EXTREME LAS PRECAUCIONES Y UTILICE GUANTES PARA PROTEGERSE LAS MANOS;
- NO coloque objetos calientes encima o cerca de objetos combustibles;
- NO maneje el aparato cerca de líquidos inflamables o gases;
- NO introduzca ningún líquido directamente en el aparato;
- UTILICE EL SENTIDO COMUN en todo momento.

Seguridad del usuario

Todos los usuarios de equipos Techne deben disponer de la información necesaria para asegurar su seguridad.

De acuerdo con las instrucciones contenidas en este manual y con las normas y procedimientos generales de seguridad, es muy importante que sólo personal debidamente capacitado opere estos aparatos. De no ser así, la protección que el equipo le proporciona al usuario puede verse reducida.

Todos los equipos Techne han sido diseñados para cumplir con los requisitos internacionales de seguridad y traen incorporados un sistema de desconexión en caso de sobretemperatura. En algunos modelos el sistema de desconexión es variable, lo que le permite elegir la temperatura según sus necesidades. En otros, el sistema de desconexión viene ya ajustado para evitar daños en el equipo.

En caso de que surgiera un problema de seguridad, desconecte el equipo de la red.

Instalación

1. Todos los aparatos Techne se suministran con un cable de alimentación. Puede ser fijo o independiente del aparato.

2. Antes de conectarlo, compruebe que el voltaje corresponde al de la placa indicadora. Conecte el cable de alimentación a un enchufe adecuado según la tabla expuesta a continuación. El equipo debe estar conectado a tierra para garantizar la seguridad eléctrica.

<i>Conexiones</i>	220/240V	110/120V
Linea	Marrón	Negro
Neutro	Azul	Blanco
Tierra	Verde/amarillo	Verde

El fusible una vez instalado protege tanto al equipo como al usuario.

Asegúrese de que los equipos marcados 230V en la placa indicadora funcionan a 220V y de que los equipos marcados 120V funcionan a 110V. No obstante, en ambos casos la velocidad de calentamiento se verá reducida en un 8% aproximadamente. La placa indicadora está situada en la parte posterior del equipo.

3. Conecte el cable a la toma de tensión en la parte posterior del equipo.

4. Sitúe el aparato en un lugar apropiado tal como una superficie de trabajo plana, o si fuera necesario incluso en una campana con extractor de humos, asegurándose de que las entradas de aire en la parte inferior no queden obstruidas.

5. Los símbolos, que pueden aparecer junto a las luces indicadoras en el panel frontal del equipo, tienen los siguientes significados:

 : Indicador de potencia

 : Indicador del calor

 : Indicador de sobretemperatura

6. Los símbolos que se encuentran en o cerca del interruptor de alimentación tienen los siguientes significados:

I : Interruptor principal encendido

O : Interruptor principal apagado

Después de su uso

Cuando haya finalizado el calentamiento de muestras, recuerde que las piezas del equipo, tales como tubos, bloques y demás accesorios, pueden estar muy calientes. Tome las precauciones mencionadas anteriormente.

Garantía

Este aparato está garantizado contra cualquier defecto material o de fabricación durante el periodo especificado en la tarjeta de garantía adjunta. Este plazo inicia a partir de la fecha de compra, y dentro de este periodo todas las piezas defectuosas serán reemplazadas gratuitamente siempre que el defecto no sea resultado de un uso incorrecto, accidente o negligencia. Mientras se encuentre bajo garantía las revisiones las debe llevar a cabo el proveedor.

A pesar de la descripción y las especificaciones de los aparatos contenidas en el Manual del Usuario, Techne se reserva por medio de este documento el derecho a efectuar los cambios que estime oportunos tanto en los aparatos como en cualquier componente de los mismos.

Este manual ha sido preparado exclusivamente para los clientes de Techne y nada de lo especificado en este folleto de instrucciones se tomará como una garantía, condición o aseveración de la descripción, comerciabilidad o adecuación para cualquier fin específico de los aparatos o sus componentes.

Mantenimiento

ESTE APARATO DEBE SER DESMONTADO SOLO Y EXCLUSIVAMENTE POR PERSONAL DEBIDAMENTE CAPACITADO.

EL RETIRAR LOS PANELES LATERALES, FRONTALES O TRASEROS SUPONE DEJAR AL DESCUBIERTO TENSION DE LA RED PELIGROSA.

EL EQUIPO NO CONSTA DE NINGUNA PIEZA DE CUYO MANTENIMIENTO SE PUEDA ENCARGAR EL USUARIO.

En el caso improbable de que experimentara algún problema con su aparato que no pudiera resolver con facilidad, debería ponerse en contacto con su proveedor y devolverlo si fuera necesario. Indique de forma detallada todos los defectos que haya notado y devuelva el equipo en su embalaje original. Techne no aceptará responsabilidad alguna por daños causados en equipos que no estuvieran debidamente embalados para su envío; si tuviera alguna duda, póngase en contacto con su proveedor. Sírvase consultar el Certificado de Descontaminación suministrado con su aparato.

1. Limpieza

Antes de limpiar su aparato, desconéctelo SIEMPRE de la fuente de alimentación y permita que se enfríe por debajo de los 50°C.

Este aparato se puede limpiar pasándole un paño húmedo enjabonado. Hágalo con cuidado para evitar que caiga agua dentro del mismo. No utilice limpiadores abrasivos.

2. Fusibles

Su aparato está protegido por uno o dos fusibles. Sólo deben cambiarlos personal debidamente capacitado. Si los fusibles se fundieron repetidamente, esto indicaría una avería grave y puede que tuviera que devolverle el aparato a su proveedor para su reparación.

THE CALIBRATOR

The Tecal Calibrator is designed to provide safe and convenient calibration of a wide range of thermal sensors. It features fast heat up times, with accuracy and repeatability.

Applications

Before using the Tecal, make sure you have read this manual carefully. If you have any queries, contact your supplier.

The Tecal unit can calibrate temperature probes without the need to return them to a specialist laboratory. To ensure accuracy the unit must be operated in an environment with a stable ambient temperature.

The thermal sensors are placed in a well in the temperature controlled block. A number of inserts with different dimension wells are available to match standard probe sizes: these are detailed towards the back of this manual.

Maintaining a set temperature

The required temperature is set on the calibrator and the operation of the probe is checked.

A NAMAS certificate can be provided, contact your dealer for details.

Warning

HIGH TEMPERATURES ARE DANGEROUS: they can cause serious burns to operators and ignite combustible material.

Techne have taken great care in the design of these units to protect operators from hazards, but operators should pay attention to the following points:

- USE CARE AND WEAR PROTECTIVE GLOVES TO PROTECT HANDS;
- DO NOT put hot objects on or near combustible objects;
- DO NOT operate the unit close to inflammable liquids or gases;
- DO NOT place any liquid directly in your Tecal unit;
- DO NOT place the unit into its carrying case if the block temperature exceeds 50°C;
- If you are using a cooling probe, make sure that water is flowing through the cooling probe BEFORE inserting the probe into the block;
- At all times USE COMMON SENSE.

Specification

The figures stated in the specification are as measured 0-50 mm from the base of the well of the insert, using an SPRT, at the time of calibration.

Measuring zone	0 to 50 mm from base of well	0" to 2" from base of well
Depth of well in insert	114.3 mm	4.5"
Temperature range	-40°C to 140°C *	-40°F to 284°F *
Temperature accuracy in measuring zone	±0.3°C	±0.54°F
Temperature uniformity in measuring zone	±0.2°C at 100°C	0.36°F at 182°F
Temperature stability after 10 minutes	±0.05°C	±0.09°F
Display resolution	0.1°C	0.1°F
Heat up rate	5 minutes 20°C to 100°C	68°F to 182°F
Cool down rate	9 minutes 100°C to 0°C	182°F to 32°F
Comms Port	9way D type	Full bi-directional RS232

* The lowest temperatures can only be achieved when the Tecal 140 is used with a chilled water supply which has a maximum pressure of 6 metres of water. However, the chilled water supply must not be switched on when the set temperature is above 40°C as this can lead to damage to the block.

Dimensions

Height	272mm	10.7"
Width	185mm	7.28"
Depth	439mm	17.28"

Wells in the block:

Central Well for inserts, see the list of inserts at the back of this book

Depth	130mm	5.1"
Diameter	38.2mm	1.5"

Working conditions

The Tecal units are designed to work safely under the following conditions:

Ambient temperature range 5°C to 40°C

Humidity Up to 95% relative humidity, non-condensing

Note: The control specifications quoted are for an ambient temperature range of 10°C to 30°C. The specification may deteriorate outside this range but the unit will still work safely.

Radio frequency interference tested and passed to EN50081-1.

Immunity Tested and passed to EN50082-1

Packing

When you receive your unit, make sure you keep the original packing in case you ever need to return it for service or repair. When returning a unit, remember to remove the insert from the temperature controlled block.

The unit must be transported in the original packing to avoid damage. The packing comprises; the unit in the soft carrying case packed with foam into an outer cardboard box. Techne accepts no responsibility for damage incurred unless the unit is correctly packed and transported in this way.

WHEN YOU SWITCH ON

When you first switch on, the display will show the edition of the software which your unit uses. For example software issue "3.13" would be shown as follows:

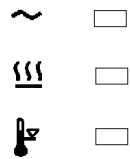

It will display this for 1 second, then the actual temperature of the block will be indicated.

The Front Panel Controls

The front panel controls consist of three buttons for controlling the display, a five digit LED display and three indicators.

The SET temperature Button

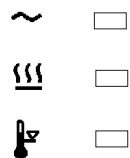

The **SET** temperature button displays the set temperature when pressed.

The UP ARROW Button

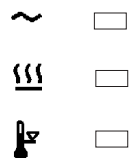

When the **SET** temperature button is held down and the **UP ARROW** button is pressed, the set temperature is increased.

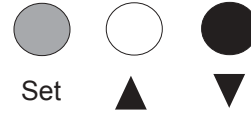
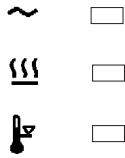
The DOWN ARROW Button

When the **SET** temperature button is held down and the **DOWN ARROW** button is pressed, the set temperature is decreased.

Speed of Change of Set Temperature

Each press of the **UP ARROW** or **DOWN ARROW** buttons will increase or decrease the set temperature by 0.1°C. If the buttons are held down the temperature change will accelerate to 5° per second

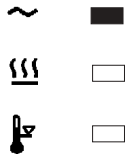
Power Indicator

The top indicator shows that there is power to the unit

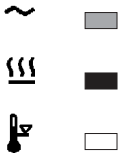
Power to the Block Indicator

The next indicator shows when there is power to the block.

When the set temperature is different to the block temperature this indicator will light. If the light is on continuously the block is getting constant power.

The only exception is described under Over-Temperature Indicator. As the temperature approaches the set temperature the indicator will flash. When set temperature is reached the indicator will stay on for shorter periods.

Sensor fault Indicator

If there should, for any reason, be a sensor fault, the bottom indicator will light. The power to the block will have been switched off and the unit will begin to return to ambient even if the power light is on (the light staying on or not depends on which circuit has sensed a fault).

Setting the units for temperature

The unit will normally be set to display in °C, if you require it to work and display in °F press both the **UP ARROW** and **DOWN ARROW** buttons at the same time. To convert back, press both buttons again.

Setting the Operating Temperature

1. To display the set temperature on the digital display, press and hold the **SET** Temperature button.
To adjust the set temperature, press the **SET** Temperature button and hold it while pressing the **UP** or **DOWN** buttons. When the **SET** Temperature button is released, the measured temperature is displayed (in degrees Celsius).
2. Power is switched on to the block (and the indicator comes on) if the set temperature is higher or lower than the block temperature.
3. When the measured temperature approaches the set temperature, the "power to the block" indicator will begin to flash. As the measured temperature stabilises the indicator will stay on for shorter periods.
4. There will be a time-lag between the block and the insert achieving the set temperature due to thermal contact between them. The display may reach temperature in 2 or 3 minutes while the insert may take 5 minutes or more to reach temperature.

Water Cooling

An extended temperature range to -40°C can be achieved on the Tecal 140 unit with a 4°C chilled water supply. The supply must have no more than 6 metres of water pressure head. However, the chilled water supply must not be switched on when the set temperature is above 40°C as this can lead to damage to the block. The cooling fan in the calibrator will automatically switch off if there is a chilled water supply.

A Techne CH-5 chiller may be used to supply chilled water but in an ambient above 20°C it may not achieve the lowest temperatures. Switch on the chiller unit before the calibrator and allow the chiller to stabilise for 15 minutes before performing a calibration. After stabilisation, temperatures between -40 and ambient can be set. Contact Techne's Sales Department for details of the chiller unit.

Connect the CH-5, or the chilled water supply, to the calibrator using suitable pipes and clips.

After Use

1. When you have finished heating samples, remember that parts of the unit – inserts and associated accessories – may be very hot. Take the precautions listed earlier. We recommend that the inserts should be allowed to cool to 70°C before being removed from the Tecal unit. They will still have to be handled with care
2. If you need to remove an insert while it is hot, fit the extractor tool into the locating holes and lift the insert out carefully. Never leave the extractor tool in the insert while it is being used in the Tecal unit.

RS232 SERIAL INTERFACE

The calibrator may send data logging information to an IBM PC or compatible computer by connecting the unit and the PC via an RS232 cable, and installing the "Calsoft" software. Contact your supplier for details.

Ensure that there is a connection made before the calibrator is switched on.

The RS232 cable must be fitted to both the unit and the PC before either unit is powered up, otherwise, data integrity cannot be guaranteed. Once the cable is fitted, it does not matter which unit is powered up first.

RS232 9-way PC serial port

ON/OFF switch

Fuses

Power inlet

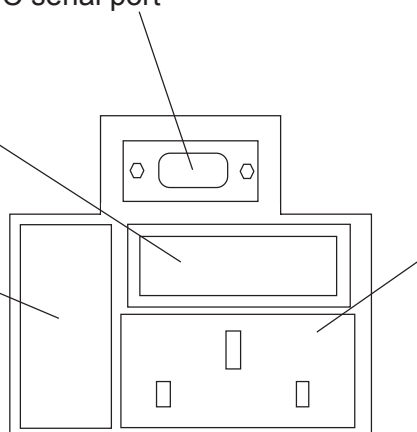

The following tables indicate the cable specifications for a 9-way PC serial port:

Calibrator		PC
<i>9-way female D type</i>		<i>9-way female D type</i>
pin	signal	pin
Case	F.GND	Case
3	TxD	3
2	RxD	2
7	RTS	7
8	CTS	8
6	DSR	6
1	CD	1
4	DTR	4
5	S.GND	5

Sending data to the PC

The procedure for sending data to the PC is described in the instructions supplied with the software. The PC must be properly connected by the RS232 cable and running Calsoft to accept or display data.

TECHNICAL INFORMATION

Brief fault finding notes and lists of replacement parts, accessories and inserts for the Tecal are given in this section.

NOTE THAT THIS EQUIPMENT SHOULD ONLY BE DISMANTLED BY PROPERLY TRAINED PERSONNEL. **REMOVING THE OUTER COVERS OR BASE EXPOSES POTENTIALLY LETHAL MAINS VOLTAGES.**

THERE ARE NO OPERATOR SERVICEABLE PARTS WITHIN THE EQUIPMENT.

General advice

In the unlikely event that you experience any problems with your Tecal which cannot be easily remedied, you should contact your supplier and return the unit if necessary. Please include any details of the fault observed and remember to return the unit in its original packing. The insert must be removed from the unit and packed separately within the case. Techne accept no responsibility for damage to units which are not properly packed for shipping: if in doubt, contact your supplier.

General fault finding

HELP display

If HELP is displayed there is a problem with the internal sensing device. The calibrator should be returned to your supplier for repair.

Cleaning your Tecal unit

Before cleaning your unit, disconnect from the power supply and allow to cool to ambient temperature.

You can clean the case of the Tecal with a cloth dipped in water or ethanol (methanol can also be used). No part of the case or cover should be immersed in the solvents.

Do not use acetone or abrasive cleaners.

Before using any cleaning or decontamination method except those recommended in this manual, the responsible body should check with Techne that the proposed method will not damage the equipment.

Fuses

If neither the power light nor display (on the front panel) is lit, one of the two fuses may have blown. Make sure there is no external cause (such as a faulty plug or lead).

Fuses should only be changed by suitably qualified personnel. If the fuses blow persistently, a serious fault is indicated and you should return the calibrator to your supplier for repair.

Never fit a fuse rated higher than the value indicated on the unit, serious damage or personal injury may result.

Replacement parts

Each unit is supplied with an extraction tool, a soft carrying case and a mains cable. The following parts may be purchased if replacements or alternatives are required.

6101058	Insert extractor
FCAB10UK	Mains cable, 230V UK units
FCABLEEU	Mains cable, 230V units
FCABLEUS	Mains cable, 120/100V units
6103711	Soft carrying case

Accessories

<i>Part N°</i>	<i>Description</i>
FCAL232	CALSOFT PC software kit
FCH5D	CH-5 Chiller 230V
FCH5P	CH-5 Chiller 120V

Inserts

Inserts are made from aluminium or aluminium-bronze and must be ordered separately from the calibrator. Each insert is stamped for identification.

A blank insert is available which may be drilled to suit your application.

Aluminium Inserts

Immersion depth 114.3 mm or 4.5"

<i>NUMBER</i>	<i>PROBE DIAMETER</i>
METRIC	
FINSALA	5 off 6mm
FINSALB	1 off each 10mm, 8mm, 6mm, 4.5mm, 3mm
FINSALC	2 off 6mm, 2 off 10mm
FINSALD	2 off 6mm, 2 off 12mm
FINSALE	1 off 6mm
FINSALZ	1 off 20mm
IMPERIAL	
FINSALF	5 off 1/4"
FINSALG	1 off each 3/8", 5/16", 1/4", 3/16", 1/8"
FINSALH	2 off 1/4", 2 off 3/8"
FINSALI	2 off 1/4", 2 off 1/2"
FINSALJ	1 off 1/4"
FINSALL	1 off 9/16"
FINSALM	1 off 5/8"
FINSALN	1 off 3/4"
FINSALO	1 off 11/16"
BLANK	
FINSALK	BLANK



Thank you for reading this data sheet.

For pricing or for further information, please contact us at our UK Office, using the details below.



UK Office

Keison Products,

P.O. Box 2124, Chelmsford, Essex, CM1 3UP, England.

Tel: +44 (0)330 088 0560

Fax: +44 (0)1245 808399

Email: sales@keison.co.uk

Please note - Product designs and specifications are subject to change without notice. The user is responsible for determining the suitability of this product.