



**Sensepoint XCD RTD (Remote Toxic Detector)  
Technical Manual**

## 1 Safety

Ensure that this Technical Manual is read and understood **BEFORE** installing / operating / maintaining the equipment. Pay particular attention to **Warnings** and **Cautions**. All document **Warnings** are listed here and repeated where appropriate at the start of the relevant chapter(s) of this Technical Manual. **Cautions** appear in the sections/sub-sections of the document where they apply.

### **WARNINGS**

*Sensepoint XCD RTD is designed for installation and use in Zone 1 or 2 hazardous areas in many countries including Europe and for Class 1 Division 1 or 2 area applications in North America.*

*Installation must be in accordance with the recognized standards of the appropriate authority in the country concerned.*

*Access to the interior of the detector, when carrying out any work, must only be conducted by trained personnel.*

*Before carrying out any work ensure local regulations and site procedures are followed. Appropriate standards must be followed to maintain the overall certification of the detector.*

*For installations where conduit is used, and the sensor is mounted directly to the Sensepoint XCD RTD, there must be a "Seal Fitting" installed for each of the cable gland entries within 18 inches of the Sensepoint XCD RTD. The total distance of the location of these Seal Fittings is 18 inches. (e.g. If all 3 gland entries are to be used, 3 Seal Fittings should be located, each within 6 inches of the wiring entrance).*

*If using an anti-seize compound, the threads should be thinly coated with an approved silicone free compound e.g. petroleum jelly*

*To reduce the risk of ignition of hazardous atmosphere, de-classify the area or disconnect the equipment from the supply circuit before opening the detector enclosure. Keep assembly tightly closed during operation.*

*Never attempt to open a junction box/enclosure or replace/refit the sensor in potentially hazardous atmospheres while power is still applied to the transmitter.*

*The detector must be earthed/grounded for electrical safety and to limit the effects of radio frequency interference. Earth/ground points are provided inside and outside the unit. The internal grounding shall be used as the primary equipment ground. The external terminal is only a supplemental bonding connection where local authorities permit or require such a connection.*

*Ensure that all screens/instrument earth/clean earth wiring is earthed/grounded at a single point (either at the controller or detector - BUT NOT BOTH) to prevent false readings or alarms that may occur due to potential earth/ground loops.*

*Take care when handling sensors as they may contain corrosive solutions.*

*Do not tamper with or in any way disassemble the sensor.*

*Do not expose to temperatures outside the recommended ranges.*

*Do not expose sensors under storage conditions to organic solvents or flammable liquids.*

*At the end of their working life, replacement electrochemical sensors for oxygen and toxic gas must be disposed of in an environmentally safe manner. Disposal should be according to local waste management requirements and environmental legislation. Alternatively, old replaceable sensors may be securely packaged and returned to Honeywell Analytics clearly marked for environmental disposal.*

*Electrochemical sensors should NOT be incinerated as this action may cause the cell to emit toxic fumes.*

*Refer to the local or national regulations relative to the installation at the site. For Europe see EN60079-29-2, EN60079-14 and EN61241-14.*

*Only assessed for ATEX for ignition hazards.*

*This equipment is designed and constructed as to prevent ignition sources arising, even in the event of frequent disturbances or equipment operating faults.*

**Note:** Ensure that a suitably rated fuse is used in the gas detection control system to protect the Sensepoint XCD RTD power supply from potential damage.

## 2 Information

This manual is applicable only for the Sensepoint XCD RTD version of the Sensepoint XCD product range.

Where “Sensepoint Toxic” is mentioned throughout this manual, it refers to the Honeywell Analytics Sensepoint product range of Toxic AND Oxygen gas sensors.

The Start-up/Surge/In rush current is dependant on the type of power supply used. The typical start-up current for Sensepoint XCD RTD is less than 800mA. Measure the start-up current using the specific power supply before installation to ensure suitability for your application.

Honeywell Analytics can take no responsibility for installation and/or use of its equipment if not done so in accordance with the appropriate issue and/or amendment of the Technical Manual.

The reader of this Technical Manual should ensure that it is appropriate in all details for the exact equipment to be installed and/or operated. If in doubt, contact Honeywell Analytics for advice.

The following types of notices are used throughout this Technical Manual:

### **WARNING**

*Identifies a hazardous or unsafe practice which could result in severe injury or death to personnel.*

*Caution: Identifies a hazardous or unsafe practice which could result in minor injury to personnel, or product or property damage.*

**Note: Identifies useful/additional information.**

Every effort has been made to ensure the accuracy of this document, however, Honeywell Analytics can assume no responsibility for any errors or omissions in this document or their consequences.

Honeywell Analytics would greatly appreciate being informed of any errors or omissions that may be found in the content of this document.

For information not covered in this document, or if there is a requirement to send comments/corrections about this document, please contact Honeywell Analytics using the contact details given on the back page.

**Honeywell Analytics reserve the right to change or revise the information supplied in this document without notice and without obligation to notify any person or organization of such revision or change. If information is required that does not appear in this document, contact the local distributor/agent or Honeywell Analytics.**

### 3 Table of contents

1 Safety	2
2 Information	3
3 Table of contents	4
4 Introduction	6
4.1 Transmitter	7
4.2 Sensepoint Toxic Gas Sensor	7
4.3 Accessories	8
5 Installation	9
5.1 Mounting and location	10
5.2 Mounting the transmitter	10
5.3 Installing the sensor	12
5.3.1 Local Sensor Mounting	12
5.3.2 Remote Sensor Mounting	13
6 Electrical connections	14
6.1 Terminal connections	15
6.2 Transmitter Wiring	15
6.2.1 Wiring from Transmitter to Controller	15
6.2.2 Wiring from Transmitter to Sensepoint Toxic	16
6.3 Power	17
6.4 Cabling	18
6.5 Cable and Earth/Ground regimes	18
6.6 Ground Terminal Wiring	19
7 Default configuration	20
8 Normal Operation	22
8.1 Display Screen	22
8.2 System Status	23
8.3 Magnetic Wand Activation	24
8.4 Operation Mode Structure	24
9 First time switch on (Commissioning)	25
9.1 Gas Selection	27
9.1.1 Gas TYPE set up	27
9.1.2 Gas Measuring RANGE set up	29
10 Response Check and Calibration	31
10.1 Zeroing and span calibration	31
11 General Maintenance	35
11.1 Operational Life	35
12 Servicing	36
12.1 Sensor replacement	36
12.2 Replacing Modules within the Transmitter	38
12.3 Faults and Warnings	39
13 Menu's and Advanced Configuration	40
13.1 Abort Function	40
13.2 Configuration Mode	40



13.2.1 Configuration mode operation table.....	43
13.3 Review Mode.....	45
14 General specification.....	48
15 Ordering information.....	49
16 Warranty statement.....	50
17 Installation Drawing.....	51
17.1 Mechanical Installation Drawing.....	51
17.2 Electronic Connection Drawing.....	52
17.3 Sensepoint XCD RTD Typical Installation Drawing.....	54
17.4 Mounting Bolt Assy Drawing.....	55
17.5 Mounting Bracket Drawing.....	56
18 Certification.....	57
18.1 China GB Ex and PA.....	57
18.2 Korea KTL.....	60
18.3 European ATEX.....	61
18.4 International IEC.....	64
18.5 ATEX Name Plate.....	66
19 Cross Interference and Cross Calibration.....	67

## 4 Introduction

The Sensepoint XCD RTD comprises a gas detector transmitter and a choice of sensors for detecting toxic gas and oxygen. The construction of Sensepoint XCD allows it to be used in hazardous area locations; it may also be used in other areas not classified as hazardous.

There are three different versions of Sensepoint XCD, The RTD version is used with Sensepoint Toxic sensors that can be locally or remotely mounted. The detectable gases for Sensepoint XCD RTD include Ammonia, Chlorine, Nitrogen, Monoxide, Nitrogen Dioxide, Sulphur Dioxide, Oxygen, Hydrogen Sulphide, Carbon Monoxide and Hydrogen.

The transmitter features a display and three programmable relays for controlling external equipment e.g. alarms, sirens, valves or switches. The transmitter provides an industry standard 3-wire, 4-20mA source or sink output for connection to a dedicated gas detection control system or PLC.

Configuration and Maintenance is carried out using a Magnetic Wand, this allows a single user to undertake routine maintenance without needing to access internal components. Sensepoint XCD RTD is suitable for use in Zone 1 or 2 hazardous areas.

Sensepoint XCD RTD comprises of the main parts as shown below.

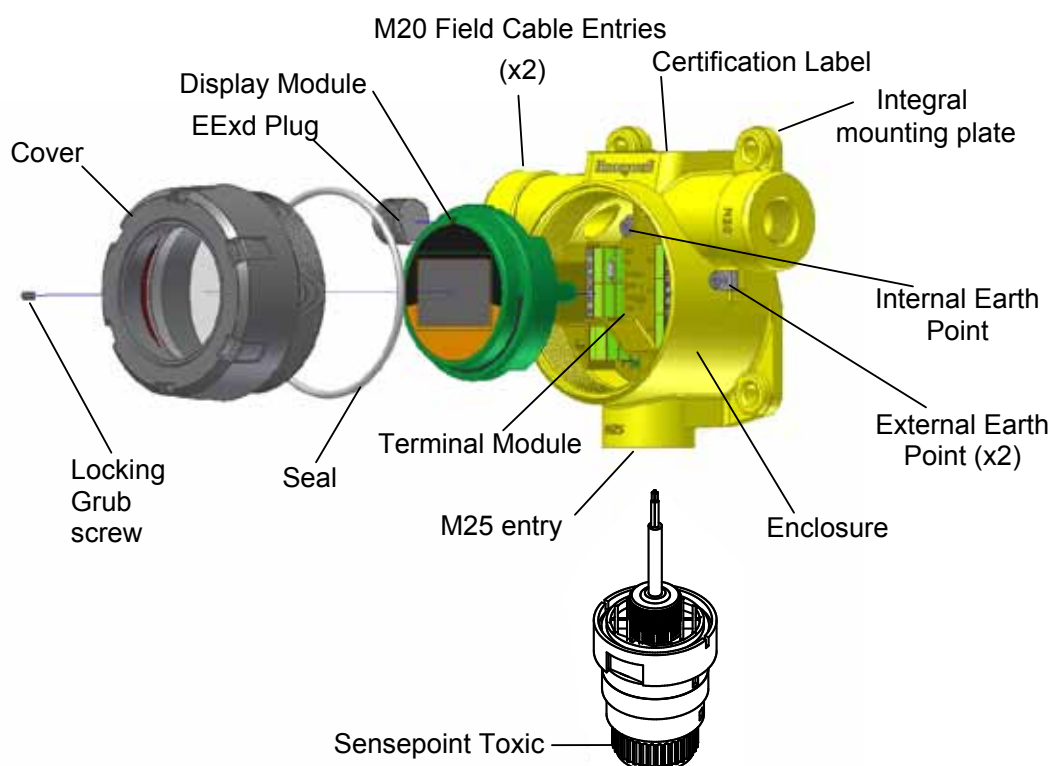

Diagram 1. – Exploded View

### 4.1 Transmitter

The transmitter enclosure has three threaded entries. The two M20 cable entries either side of the upper part of the transmitter housing are for connecting the power source, signal output and relay contacts to associated signalling equipment. The bottom M25 entry allows local mounting of a Sensepoint Toxic sensor or cable entry when using a remotely mounted sensor. There is a mounting plate incorporated into the transmitter housing allowing for various mounting configuration options.

A local LCD provides gas type, concentration, alarm and operating status. The display provides numerical, bar graph and icon information.

Diagnostic information may also be displayed when the transmitter is interrogated using a magnet. The transmitter cover has a glass window which allows use of the Magnetic Wand to activate the three user interface magnetic switches that are located on the front of the display module. The magnet also enables a non intrusive, one-man calibration and configuration facility for the Sensepoint XCD RTD.

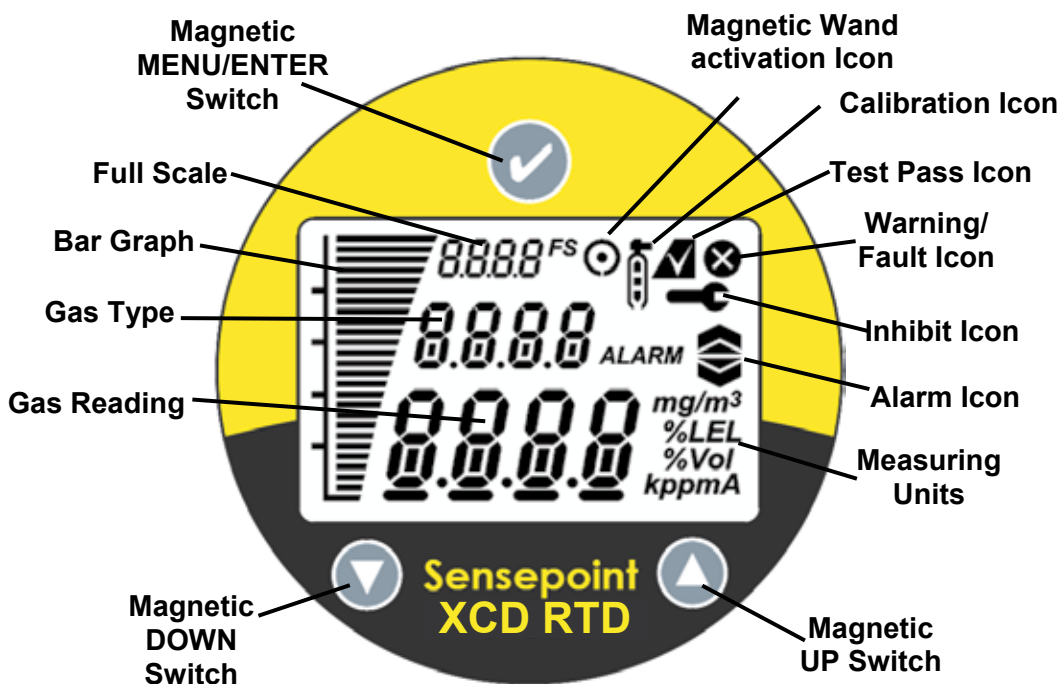

Diagram 2: Sensepoint XCD RTD Display and Magnetic Switches

### 4.2 Sensepoint Toxic Gas Sensor

The Sensepoint XCD RTD transmitter is designed to work with a range of Sensepoint toxic sensors (see section 7 for details of gases and ranges available) .

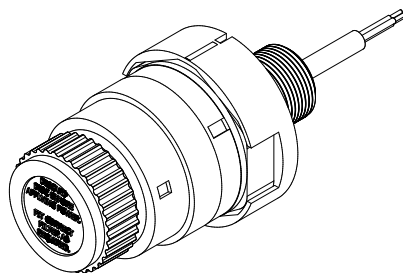
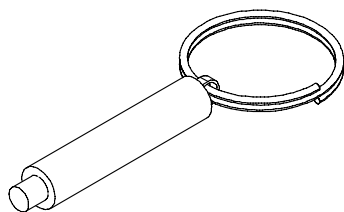

Diagram 3: Sensepoint Toxic Sensor Head for Sensepoint XCD RTD

### 4.3 Accessories

A range of accessories are available to allow use of Sensepoint XCD RTD in a wide variety of applications. These include Pipe mounting bracket, Sunshade deluge cover, Sensor collecting cone, Sensor flow Housing and Remote sensor mounting junction boxes.



Magnetic wand

The magnetic wand (P/N: SPXCDMAG) is used as a tool to allow the user to communicate with the Sensepoint XCD RTD transmitter for the purpose of configuration, calibration and interrogating system status, (supplied with XCD kit).

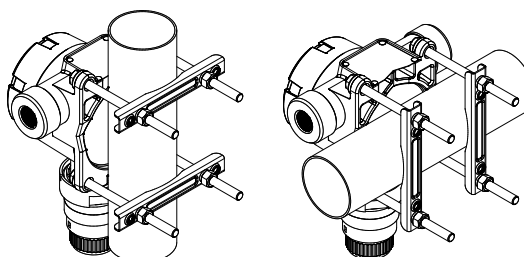

Pipe mounting bracket

The Pipe Mounting Bracket (P/N: SPXCDMTMB) is an optional accessory and may be used to allow the Sensepoint XCD RTD to be installed onto a dedicated mounting post or existing structure at the desired location.

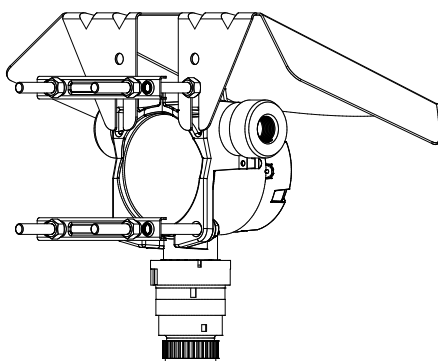

Sunshade Deluge Cover

The XCD Sunshade Deluge Cover (P/N: SPXCDSDP) is an optional accessory that may be fitted to the integral mounting plate. This accessory is designed to protect XCD from overheating in exposed hot and arid climates, particularly offering additional protection from thermal shock in Tropical Environments

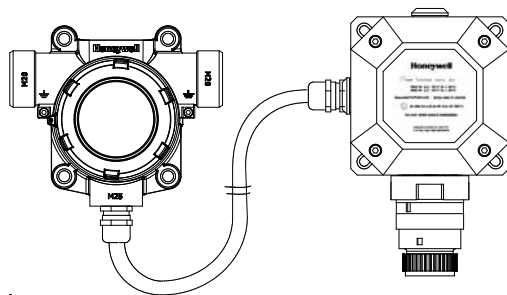

Remote Sensor Mounting

The Junction Box(P/N: 00780-A-0100) is an optional accessory can be used for remote sensor mounting. Make the connection from the junction box to transmitter using suitable cable and cable gland.

## 5 Installation

### WARNINGS

*Sensepoint XCD is designed for installation and use in Zone 1 or 2 hazardous areas in many countries including Europe and for Class 1 Division 1 or 2 area applications in North America.*

*Installation must be in accordance with the recognized standards of the appropriate authority in the country concerned.*

*Access to the interior of the detector, when carrying out any work, must only be conducted by trained personnel.*

*Before carrying out any work ensure local regulations and site procedures are followed. Appropriate standards must be followed to maintain the overall certification of the detector.*

*Care should be taken when removing and refitting the Sensepoint XCD plug-in Sensor to the Sensor Socket so that damage to the connection pins can be avoided.*

*For installations where conduit is used, and the sensor is mounted directly to the Sensepoint XCD, there must be a "Seal Fitting" installed for each of the cable gland entries within 18 inches of the Sensepoint XCD. For installations where the sensor will be mounted remotely from Sensepoint XCD, an additional "Seal Fittings" will be required: One at each of the conduit entries for the power/signal/relay contact outputs and one at the sensor wiring entrance. The total distance of the location of these Seal Fittings is 18 inches. (e.g. If all 3 gland entries are to be used, 3 Seal Fittings should be located, each within 6 inches of the wiring entrance).*

*If using an anti-seize compound, the threads should be thinly coated with an approved silicone free compound e.g. petroleum jelly*

*To reduce the risk of ignition of hazardous atmosphere, de-classify the area or disconnect the equipment from the supply circuit before opening the detector enclosure. Keep assembly tightly closed during operation.*

*Never attempt to open a junction box/enclosure or replace/refit the sensor in potentially hazardous atmospheres while power is still applied to the transmitter.*

*The detector must be earthed/grounded for electrical safety and to limit the effects of radio frequency interference. Earth/ground points are provided inside and outside the unit. Ensure that all screens/instrument earth/clean earth wiring is earthed/grounded at a single point (either at the controller or detector - BUT NOT BOTH) to prevent false alarms due to earth/ground loops.*

*Take care when handling sensors as they may contain corrosive solutions.*

*Do not tamper with or in any way disassemble the sensor.*

*Do not expose to temperatures outside the recommended ranges.*

*Do not expose sensors under storage conditions to organic solvents or flammable liquids.*

*At the end of their working life, replacement electrochemical sensors for oxygen and toxic gas must be disposed of in an environmentally safe manner. Disposal should be according to local waste management requirements and environmental legislation.*

*Alternatively, old replaceable sensors may be securely packaged and returned to Honeywell Analytics clearly marked for environmental disposal.*

*Electrochemical sensors should NOT be incinerated as this action may cause the cell to emit toxic fumes.*

*Refer to the local or national regulations relative to the installation at the site. For Europe see EN60079-29-2, EN60079-14 and EN61241-14.*

*Only assessed for ATEX for ignition hazards.*

*This equipment is designed and constructed as to prevent ignition sources arising, even in the event of frequent disturbances or equipment operating faults.*

**Note: Ensure that a suitably rated fuse is used in the gas detection control system to protect the Sensepoint XCD RTD power supply from potential damage.**

### 5.1 Mounting and location

**Caution: The location of gas detectors should be made in accordance with any relevant local and national legislation, standards or codes of practice. Always replace sensors with a sensor of the same type.**

Gas detectors should be mounted where a potential hazard of gas is most likely to be present. The following points should be noted when locating gas sensors.

- When locating detectors consider the possible damage caused by natural events e.g. rain or flooding.
- Consider ease of access to the gas detector for functional testing and servicing.
- Consider how escaping gas may behave due to natural or forced air currents.

**Note: The placement of gas detectors should be determined following the advice of experts having specialist knowledge of gas dispersion, experts having knowledge of the process plant system and equipment involved, safety and engineering personnel. The agreement reached on the location of detectors should be recorded.**

The Honeywell Analytics Gas Book may be referred to for further useful information regarding gas detector mounting and location. Please contact your local sales/service agent for a copy.

### 5.2 Mounting the transmitter

The Sensepoint XCD transmitter has an integral mounting plate consisting of four mounting holes on the transmitter body. The transmitter may be fixed directly to a surface mounting, or to a horizontal or vertical pipe/structure, 40.0-80.0mm (1.6 to 3.1 inches) in diameter/cross section. The Pipe Mounting Bracket accessory (optional accessory) may be used for this purpose.

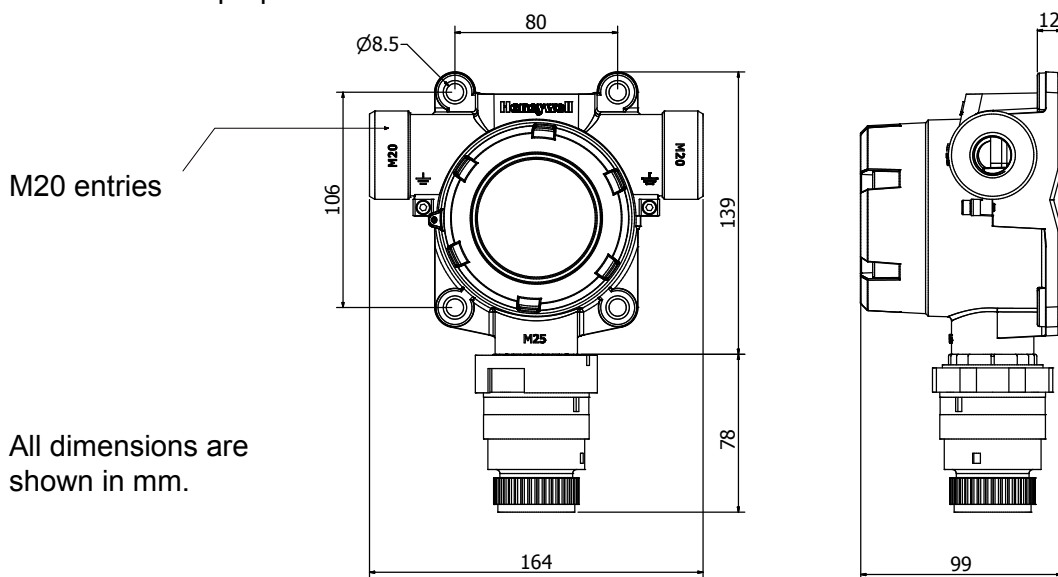

Diagram 4: Outline and mounting dimensions

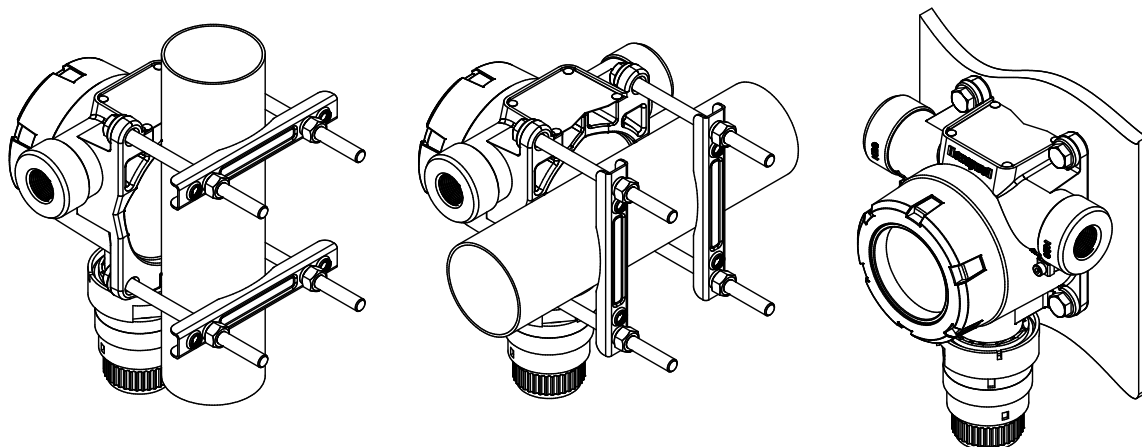

Diagram 5: Mounting arrangements

To mount the Sensepoint XCD transmitter to a Vertical or Horizontal pipe/structure, use the optional XCD Mounting Kit and following procedure:

1. Fit the four spring washers, then the plain washers to the M8 x 80mm SS316 bolts.
2. Pass the four bolts through the four mounting holes of the transmitter housing.
3. **Note:** If the XCD sunshade is to be used then fit the sunshade and the two locking bolts and washers to the M8 x 80 bolts.
4. Place the transmitter housing against the mounting position and fit the two “U” channel mounting bars the other side of the Pipe/Structure.
5. Secure bolts to the threaded holes of the “U” channel mounting bars.
6. Tighten the four bolts securely, (but do not over-tighten) until the transmitter housing cannot be moved by hand on its mounting position.

**Note: For further details of installation please see section 17.**

### 5.3 Installing the sensor

The Sensepoint toxic sensor can be mounted directly to the bottom entry of the XCD RTD transmitter or remotely to a suitable junction box.

#### 5.3.1 Local Sensor Mounting

To mount a sensor directly to the Sensepoint XCD RTD transmitter follow the procedure below

1. Remove the transmitter's cover by loosening the locking screw and unscrewing the cover in a counter-clockwise direction.
2. Remove the display module by firmly pulling it away from the enclosure without twisting it.
3. Feed the sensor wires through the bottom entry into the terminal area.
4. Firmly screw the sensor thread into the bottom entry.
5. Connect the sensor wires to the terminals as shown in section 6.

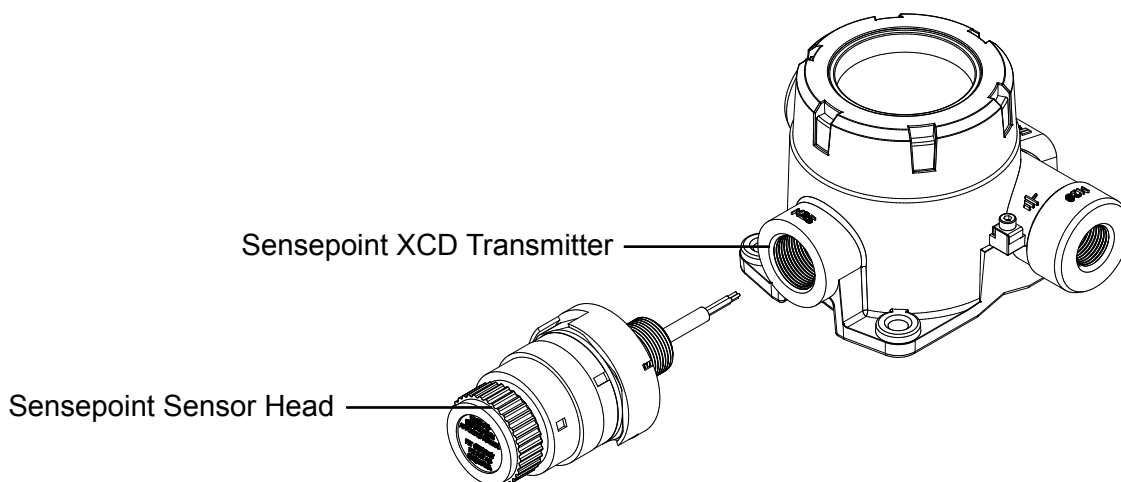

Diagram 6: Installing the Sensor

#### **WARNINGS**

***Care should be taken when removing and refitting the Sensepoint plug-in Sensor Cartridge so that damage to the connection pins can be avoided.***

***If using an anti-seize compound, the threads should be thinly coated with an approved silicone free compound e.g. petroleum jelly***

***Take care when handling old sensors as they may contain corrosive solutions.***

***The equipment is designed and constructed as to prevent ignition sources arising, even in the event of frequent disturbances or equipment operating faults.***

***Only assessed for ATEX for ignition hazards.***



### 5.3.2 Remote Sensor Mounting

A remotely mounted sensor should be mounted using a suitable junction box or approved electrical conduit scheme. For further details regarding mounting sensors to suitable junction boxes refer to the relevant sensor manual.

To remotely mount the sensor, follow the procedure below.

1. Select a suitably certified junction box.
2. Fit the sensor to the junction box (refer to sensor manual)
3. Connect the junction box to the transmitter using suitable cable and cable glands

**Note: The maximum cable length between the remotely mounted sensor and the XCD RTD transmitter is 30 meters(100 feet).**

4. Terminate the wires from the sensor in the transmitter as shown in section 6.

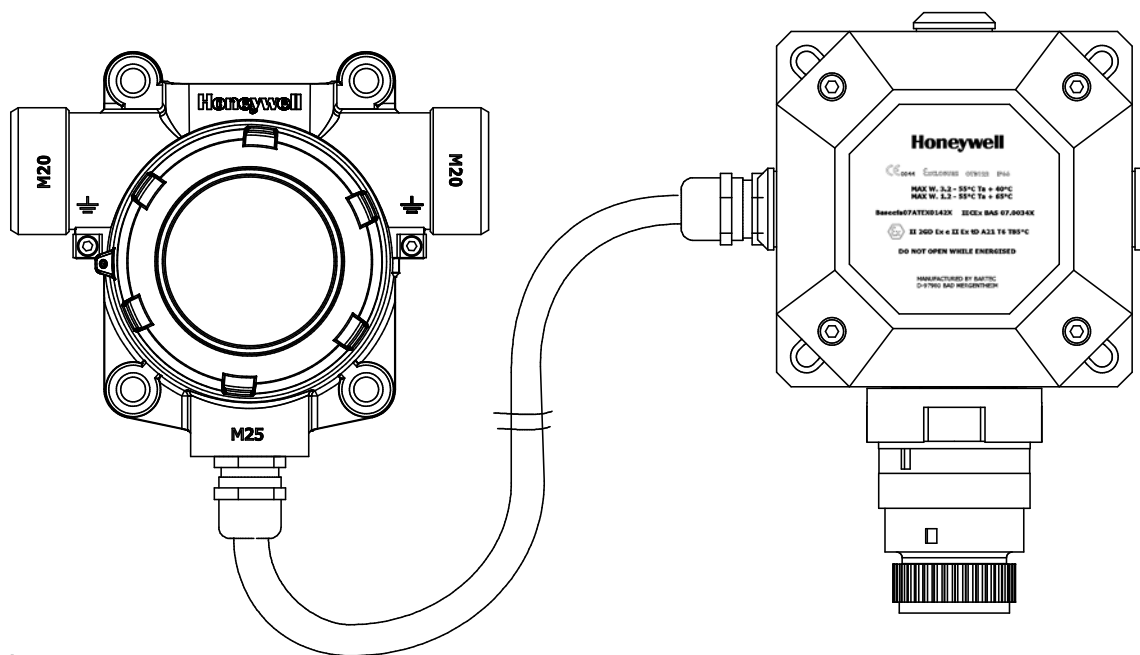

Diagram 7: Remote Sensor Mounting

## 6 Electrical connections

### **WARNINGS**

*Sensepoint XCD is designed for installation and use in Zone 1 or 2 hazardous areas in many countries including Europe and Class 1 Division 1 or 2 area applications in North America.*

*Installation must be in accordance with the recognized standards of the appropriate authority in the country concerned.*

*Access to the interior of the detector, when carrying out any work, must only be conducted by trained personnel.*

*Before carrying out any work ensure local regulations and site procedures are followed. Appropriate standards must be followed to maintain the overall certification of the detector.*

*Care should be taken when removing and refitting the Sensepoint XCD Sensor Cartridge to the Sensor Socket so that damage to the connection pins can be avoided.*

*For installations where conduit is used, and the sensor is mounted directly to the Sensepoint XCD, there must be a "Seal Fitting" installed for each of the cable gland entries within 18 inches of the Sensepoint XCD. The total distance of the location of these Seal Fittings is 18 inches. (e.g. If all 3 gland entries are to be used, 3 Seal Fittings should be located, each within 6 inches of the wiring entrance).*

*If using an anti-seize compound, the threads should be thinly coated with an approved silicone free compound e.g. petroleum jelly*

*To reduce the risk of ignition of hazardous atmosphere, de-classify the area or disconnect the equipment from the supply circuit before opening the detector enclosure. Keep assembly tightly closed during operation.*

*Never attempt to open a junction box/enclosure or replace/refit the sensor in potentially hazardous atmospheres while power is still applied to the transmitter.*

*The detector must be earthed/grounded for electrical safety and to limit the effects of radio frequency interference. Earth/ground points are provided inside and outside the unit. Ensure that all screens/instrument earth/clean earth wiring is earthed/grounded at a single point (either at the controller or detector - BUT NOT BOTH) to prevent false alarms due to earth/ground loops.*

*Take care when handling sensors as they may contain corrosive solutions.*

*Do not tamper with or in any way disassemble the sensor.*

*Do not expose to temperatures outside the recommended ranges.*

*Do not expose sensors under storage conditions to organic solvents or flammable liquids.*

*At the end of their working life, replacement electrochemical sensors for oxygen and toxic gas must be disposed of in an environmentally safe manner. Disposal should be according to local waste management requirements and environmental legislation.*

*Alternatively, old replaceable sensors may be securely packaged and returned to Honeywell Analytics clearly marked for environmental disposal.*

*Electrochemical sensors should NOT be incinerated as this action may cause the cell to emit toxic fumes.*

*Refer to the local or national regulations relative to the installation at the site. For Europe see EN60079-29-2, EN60079-14 and EN61241-14.*

### 6.1 Terminal connections

**Note:** Ensure that none of the wires in the terminal area cause an obstruction when refitting the Display Module. Ensure that the socket on the Display Module is fully engaged in the Display Module Connector on the Terminal Module.

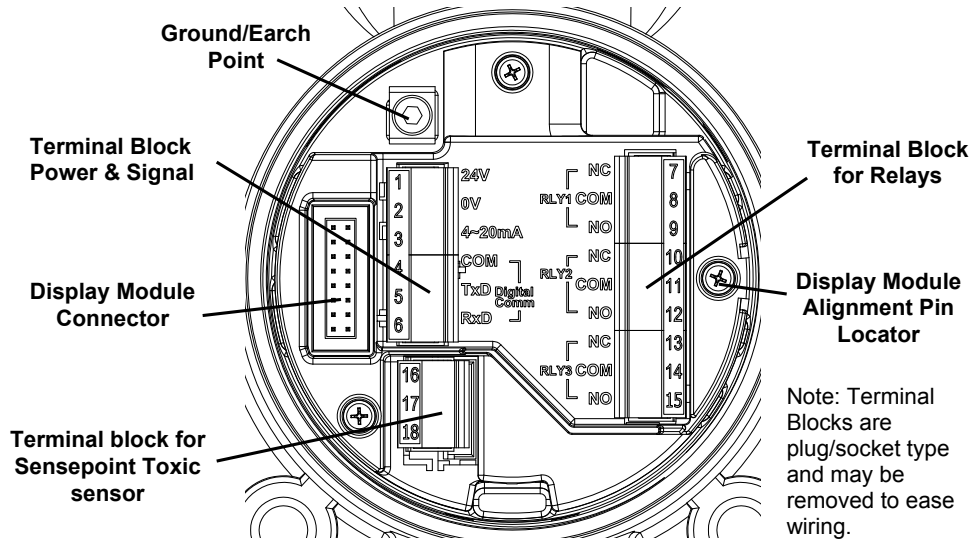

Diagram 8: Sensepoint XCD RTD Terminal module

### 6.2 Transmitter Wiring

**Caution:** All electrical connections should be made in accordance with any relevant local or national legislation, standards or codes of practice.

#### 6.2.1 Wiring from Transmitter to Controller

The Sensepoint XCD transmitter may be wired in either Current SOURCE or Current SINK configuration. These two options are offered to allow greater flexibility in the type of control system that it can be used with. SOURCE/SINK is selectable via the switch located on the back side of the display module; accessible by removing the display module during installation / commissioning (see section 9).

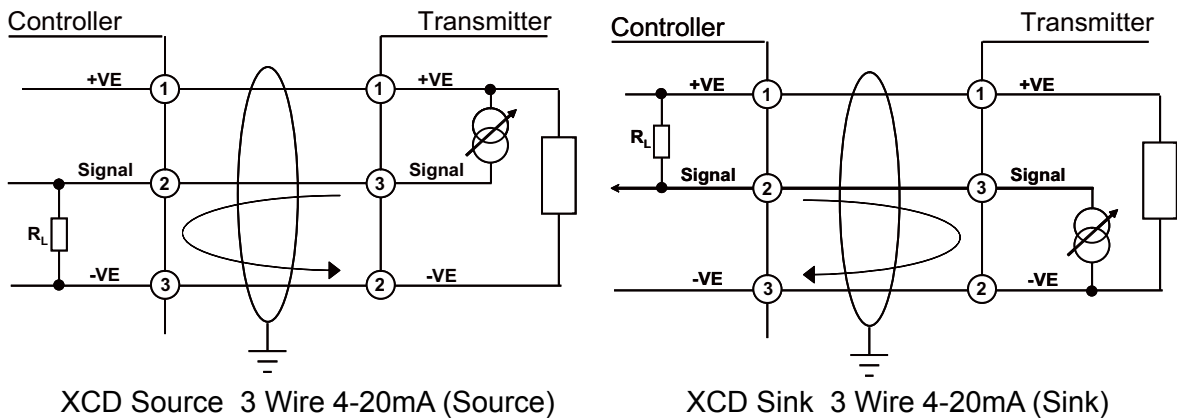

**Note: Terminate cable screen at transmitter or controller, not both. 250ohm load resistor (RL) is installed in the factory, In case of connection with controller, this resistor should be removed because controller has load resistor internally.**

Terminal Module Connections			
Terminal Number	Marking	Connection	Description
1	24V	+VE Supply(18-32VDC)	Controller Connections
2	0V	-VE Supply(0VDC)	
3	4~20mA	Current Output Signal	
4	COM	Drain	MODBUS RTU. RS485 (Pending)
5	TxD	MODBUS B (+)	
6	RxD	MODBUS A (-)	
7	RLY1/NC	Normally Closed	Programmable Relay 1 (Default A1)
8	RLY1/COM	Common	
9	RLY1/NO	Normally Open	
10	RLY2/NC	Normally Closed	Programmable Relay 2 (Default A2)
11	RLY2/COM	Common	
12	RLY2/NO	Normally Open	
13	RLY3/NC	Normally Closed	Programmable Relay 3 (Default Fault)
14	RLY3/COM	Common	
15	RLY3/NO	Normally Open	
16	+VE(Red)	+24V DC	Sensor Connection for RTD
17	-VE(Blue)	4~20mA	
18	Unused		

Table 1: Sensepoint XCD RTD Terminal connections

### 6.2.2 Wiring from Transmitter to Sensepoint Toxic

The sensor wiring for XCD RTD allows a mA input range of 0mA to 24mA max, and it will be saturated to 24mA when more than 24mA current is applied to the XCD RTD.

2 Wire 4~20mA (Source)

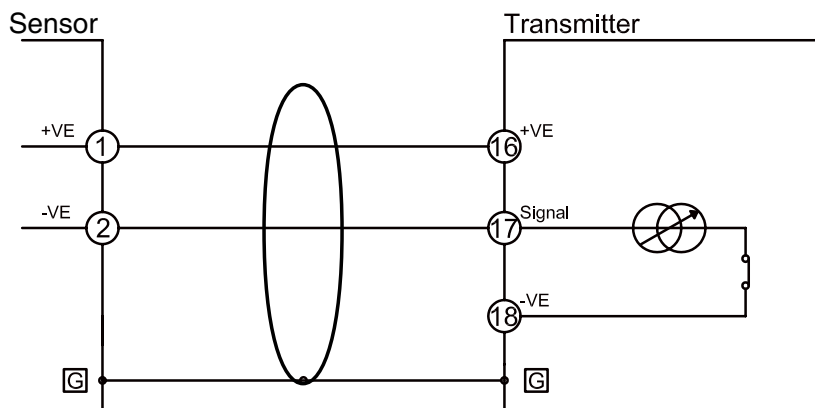

**Note: Ensure that the earth from the Sensepoint Toxic Sensor is connected to the Ground/Earth Point.**

### 6.3 Power

The Sensepoint XCD transmitter requires a power supply from the controller of between 18Vdc and 32Vdc. Ensure that a minimum supply of 18Vdc is measured at the sensor, taking into account the voltage drop due to cable resistance.

The maximum loop resistance in the field cable is calculated as follows:

$$R_{loop} = (V_{controller} - V_{detector\ min}) / I_{detector}$$

Example;

The controller is supplying a nominal 24Vdc ( $V_{controller}$ ), the detector minimum allowable voltage is 18Vdc ( $V_{detector\ min}$ ), therefore the maximum allowable voltage drop between the controller and detector is 6Vdc; this means a voltage drop of 3V in each core (+ve core and -ve core).

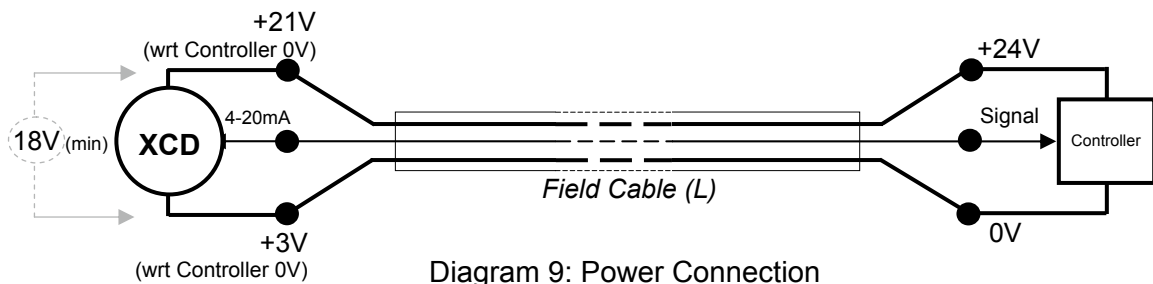

Diagram 9: Power Connection

Power consumption of the detector is 5.0W. The current required to drive the detector at the minimum voltage is ( $I = P / V$ ),  $5 / 18 = 278\text{ mA}$  ( $I_{detector}$ ).

So, the maximum field cable loop resistance ( $R_{loop}$ ) =  $6 / 0.278 = 22\text{ Ohms}$ , or  $11\text{ Ohms}$  per core, (allowing for component variations, losses, etc.).

The following tables show the maximum cable distances between the controller and transmitter assuming a voltage drop of 3V in each core and for different cable parameters. The tables are examples only and actual cable parameters and source power supply voltage for the application should be used to calculate the maximum cable distance allowed at the installation site.

Typical cable data		Maximum Cable length (L)	
Cable size (cross sectional area)	Cable resistance $\Omega/\text{km}$ ( $\Omega/\text{mi}$ )	Meters	Feet
0.5mm <sup>2</sup> (20AWG*)	36.8 (59.2)	299	981
1.0mm <sup>2</sup> (17AWG*)	19.5 (31.4)	564	1850
1.5mm <sup>2</sup> (16AWG*)	12.7 (20.4)	866	2841
2.0mm <sup>2</sup> (14AWG*)	10.1 (16.3)	1089	3573
2.5mm <sup>2</sup> (13AWG*)	8.0 (12.9)	1375	4511
*nearest equivalent			

Table 2: Maximum cable distances

### 6.4 Cabling

The use of industrial grade, suitably armoured field cable is recommended.

For example, screened 3 cores (plus screen 90% coverage), suitably mechanically protected copper cable with a suitable M20 explosion-proof gland, or 3/4" NPT steel conduit, with 0.5 to 2.5 mm<sup>2</sup> (20 to 13 AWG) conductors. Ensure the cable gland is installed correctly and fully tightened. All unused cable/conduit entries must be sealed with a suitable certified sealing plug (one plug is supplied).

### 6.5 Cable and Earth/Ground regimes

Effective Earth/Ground bonding is important to ensure good EMC and RFI immunity.

The following diagrams show examples of how to earth/ground bond the cable at enclosures. The same principles apply to conduit installations. These bonding techniques provide good RFI/EMC performance. Earth/ground loops must be avoided to prevent the risk of false signal variation.

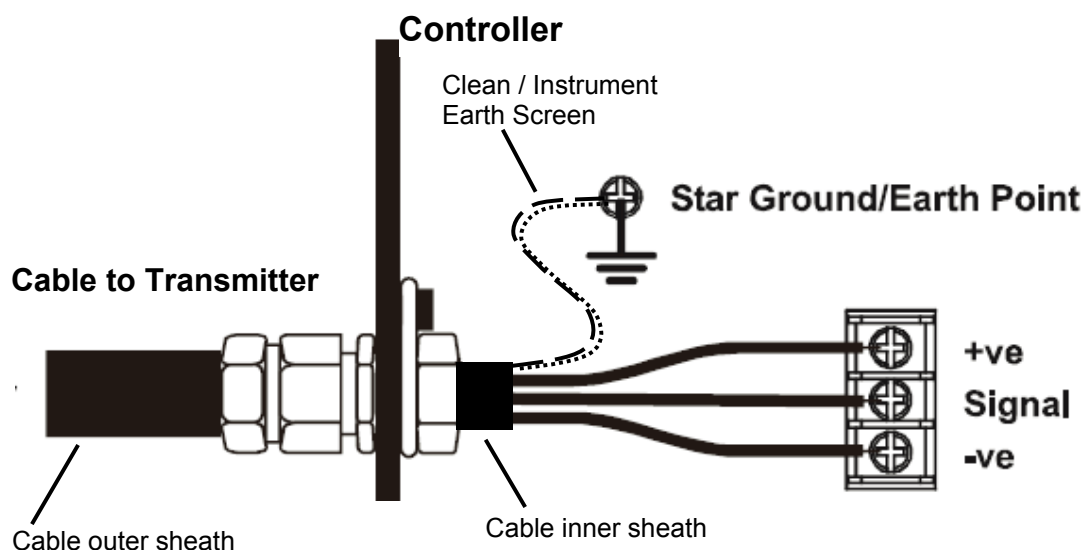

Diagram 10: Controller Grounding

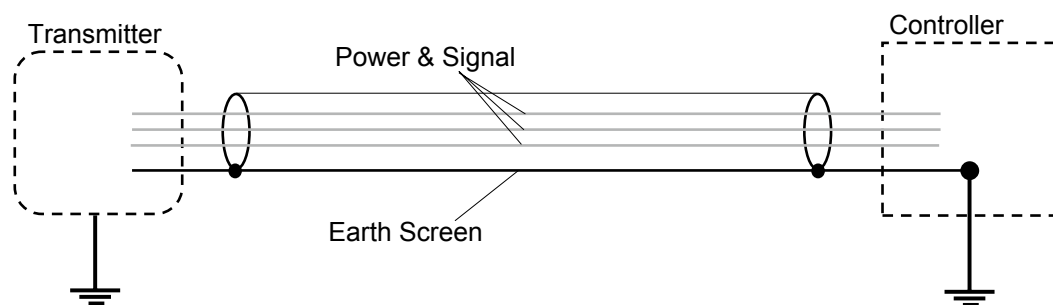
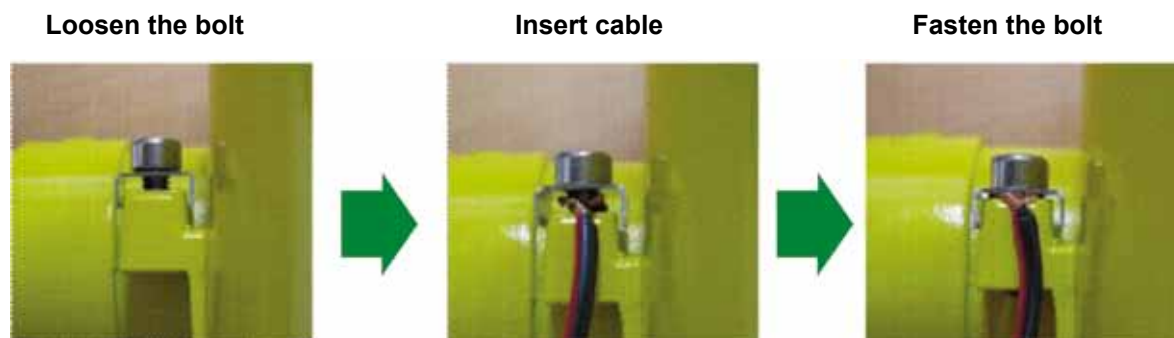

Diagram 11: System grounding

The Earth Screen of the field cable should be “tied to Earth” or connected to Ground at one point only. It is common practise to adopt a STAR EARTH connection regime where all instrumentation Screens are connected at one common point. The Screen at the other end of the cable should be “parked” or terminated into a blank terminal.

The following diagrams show how to install the wire into the ground screw of the enclosure.



## 6.6 Ground Terminal Wiring

**Internal Ground connection:** Utilize the shield of the wiring cable recommended in the wiring instructions. For connection to this terminal. Twist the shield wire to avoid stray shield wires, Loosen the screw sufficiently and wrap the wire around the screw in a “U” shape. Raise the clamp and place the wire between the clamp and ground base, lower the clamp and tighten the screw to 6.9lb-in torque.

**External Ground Connection:** If required by local authority, Utilize a No 14 AWG copper, (Stranded or Solid), wire. Loosen the screw sufficiently to enable ‘wrapping the wire around the screw in a “U” shape. Raise the clamp and place the wire between the clamp and ground base, lower the clamp and tighten the screw to 10.4lb-in torque.

## 7 Default configuration

The Sensepoint XCD transmitter is supplied with the following default configuration.

Function	Value/Setting	Meaning
Signal output	$\geq 0.0 < 1.0$ mA	Fault (refer to table 5 section 12.3 for details)
	2.0 mA or 4.0 mA (17.4mA)	Inhibit (during configuration/user settings) For Oxygen, 2.0 mA or 17.4 mA
	4.0 mA to 20.0 mA	Normal gas measurement
	22.0 mA	Maximum over range
Alarm Relay 1*	Value is sensor dependant	Lower alarm level
	De-energized	Energizes on alarm
	Contact Normally Open (NO)	Closes on alarm
Alarm Relay 2*	Value is sensor dependant	Higher alarm level
	De-energized	Energizes on alarm
	Contact Normally Open (NO)	Closes on alarm
Fault Relay	$< 1$ mA	Detector Fault
	Energized	De-energizes on alarm
	Contact Normally Open (NO)	Closes on alarm
Inhibit	2.0 mA (default) or 4.0 mA for Toxic and Flammable 2.0 mA (default) or 17.4 mA For Oxygen	Signal output inhibited during menu use. If any relay is set to inhibit relay, then inhibit relay will be activated.
Timeout	Disabled	No inhibit timeout. The detector waits for a button press before returning to the previous state/setting. Timeout period can be set in 'Configure Inhibit' menu in <b>Configuration Mode</b> .
Password	0000 (Disabled)	0000 (Password disabled). If changed then password is activated.
Location (Tag Number)	0000	Optional feature to identify the location or User's "Tag" number of the XCD
Gas Type	CO	Gas type must be set up manually during commissioning, see section 9.1 for procedure on how to set the Gas Type and measuring range of the sensor to be used with Sensepoint XCD RTD.
Temperature	$^{\circ}\text{C}$	Option to have $^{\circ}\text{C}$ or $^{\circ}\text{F}$

\* Alarm relays automatically reset when reading falls within alarm thresholds. If relay configured to LATCH, then relays must be reset using the Magnetic Wand.

Table 3: Default configuration



Gas Name	Displayed Name	Range	Lower Alarm	Lower Alarm Type	Higher Alarm	Higher Alarm Type	Lowest alarm level
Hydrogen Sulfide	H <sub>2</sub> S	20.0 ppm	4.0ppm	Rising	8.0ppm	Rising	2.0ppm
		50.0 ppm	10.0ppm	Rising	20.0ppm	Rising	5.0ppm
		100 ppm	20ppm	Rising	40ppm	Rising	10ppm
Carbon Monoxide	CO	100 ppm	30ppm	Rising	60ppm	Rising	10ppm
		200 ppm	40ppm	Rising	80ppm	Rising	20ppm
		500 ppm	100ppm	Rising	200ppm	Rising	50ppm
Chlorine	Cl <sub>2</sub>	5.0 ppm	0.5 ppm	Rising	2.0ppm	Rising	0.5ppm
		15.0 ppm	1.5 ppm	Rising	6.0ppm	Rising	1.5ppm
Ammonia	NH <sub>3</sub>	50.0 ppm	20.0ppm	Rising	30.0ppm	Rising	5.0ppm
		100 ppm	20ppm	Rising	40ppm	Rising	10ppm
		1000 ppm	200ppm	Rising	400ppm	Rising	100ppm
Hydrogen	H <sub>2</sub>	1000 ppm	200ppm	Rising	400ppm	Rising	100ppm
	H <sub>2</sub>	9999 ppm	2000ppm	Rising	4000ppm	Rising	1000ppm
Nitrogen Monoxide	NO	100 ppm	20ppm	Rising	40ppm	Rising	10ppm
Sulphur Dioxide	SO <sub>2</sub>	15.0 ppm	2.0ppm	Rising	6.0ppm	Rising	1.5ppm
	SO <sub>2</sub>	50.0 ppm	5.0ppm	Rising	20.0ppm	Rising	5.0ppm
Nitrogen Dioxide	NO <sub>2</sub>	10.0 ppm	2.0ppm	Rising	4.0ppm	Rising	1.0ppm
Oxygen	O <sub>2</sub>	25.0% V/V	19.5%Vol	Falling	23.5%Vol	Rising	10.0%Vol

Table 4: Gas Type and measuring range

**For details of how to change the configuration of the Sensepoint XCD please refer to section 13.**

## 8 Normal Operation

Sensepoint XCD RTD is supplied configured and ready for use according to the “Default Settings” table shown above. However these setting may be tailored to a specific application requirement using the Sensepoint XCD RTD configuration menu system.

Access to the Sensepoint XCD RTD transmitter’s configuration menus system is via the Magnetic Activation Tool.

### 8.1 Display Screen

The Sensepoint XCD RTD display features an LCD with Numeric and bar-graph gas concentration data, alpha-numeric warning and status indication, a target for magnetic switch activation and the UP/DOWN/ESC/ENTER zones for remote configuration. The LCD is also backlit with hi-intensity multi-colour LED indicator to show NORMAL, ALARM and FAULT status.

During normal operation the instrument display shows a steady GREEN backlight.

During Low and High Gas Alarm it displays a flashing RED backlight

During Fault condition the instrument display shows a flashing YELLOW backlight.

The screen is visible through the window of the transmitter’s cover. The display shows the gas concentration (both graphically and numerically), range, units, alarm/ fault status, etc.

**Note: The detector display may become sluggish in sub-zero temperatures and possibly unclear at temperatures below -40 °C, but the detector continues its gas monitoring function. The display is not damaged and recovers when the temperature increases.**

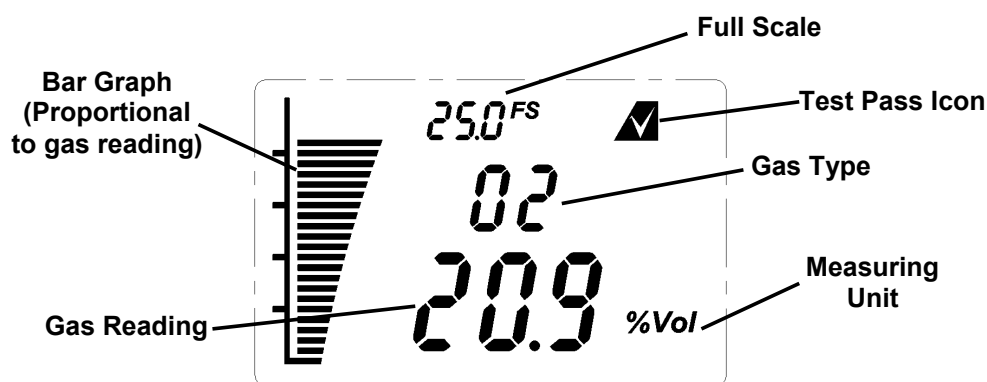

Diagram 12: Example of a O<sub>2</sub> Transmitter Display screen – Normal Operation

## 8.2 System Status

Display indications, current output and relay states for various operational conditions are shown in the following table. For further details of error messages and trouble shooting see section 12.3.

System Status						
Status	Display	Current Output	Relay			Back Light
			A1	A2	Fault	
Fault: Circuit or sensor error	F-XX fault number with fault icon blinking	0-1.0 mA			✓	Yellow, flashing
System Fault	N/A	0-0.15mA				
Note: In the event of processor failure the watchdog will automatically reset the system for recovery.						
Warning	W-XX warning number with fault icon blinking	Dependent on system status				Green Steady
Normal	0.0 Gas concentration	4-20 mA				Green Steady
Alarm 1	Gas concentration. 1 <sup>st</sup> alarm icon blinking	4-20 mA	✓			Red, flashing
Alarm 2	Gas concentration. 2 <sup>nd</sup> alarm icon blinking	4-20 mA	✓ <sup>1</sup>	✓		Red, flashing
Over-range	Full scale icon and reading blinking	22mA	✓	✓ <sup>2</sup>		Red, flashing
Inhibit	Inhibit icon dependent on Menu command. If any relay is set to inhibit relay, then inhibit relay will be activated.	2 or 4mA depending on configuration. Note: 2 or 17.4mA for Oxygen version				Green Steady

Table 5: System status

**Note:**

**1. For Oxygen, A1 relay will not be activated because AL1 is configured to activate above 23.5 %Vol (in Rising Alarm configuration).**

**2. For Oxygen, A2 relay will not be activated because AL2 is configured to activate below 19.5 %Vol (in Falling Alarm configuration).**

### 8.3 Magnetic Wand Activation

The magnetic wand is used as a tool to allow the user to communicate with the Sensepoint XCD RTD transmitter. Communication with the XCD RTD is achieved by positioning the Magnetic Wand at one of three different positions on the front glass window of the Sensepoint XCD RTD transmitter. Activation of the switches is verified by observing the Magnetic Wand Activation Icon on the LCD RTD display

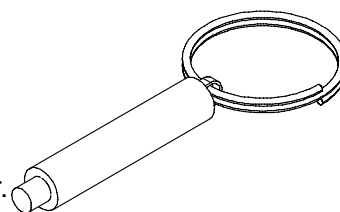

Hold the Magnetic Wand in position for up to 2 seconds = ●

Hold the Magnetic Wand in position for 3 seconds or more = ⊙

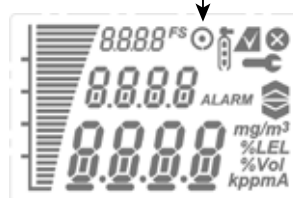

### 8.4 Mode Structure

Sensepoint XCD RTD has 3 operating modes.

1. **Monitoring mode**, is the normal operating status while XCD RTD measures and displays gas concentration. The fault/warning status is periodically checked, relay contacts are activated according to the configuration.
2. **Configuration mode**, this mode allows parameters relating to the configuration of the Transmitter functions to be changed according to specific needs. This mode can be protected by a password mechanism to prevent unauthorised changes being made.
3. **Review mode**, allows the user to view the current configuration settings.

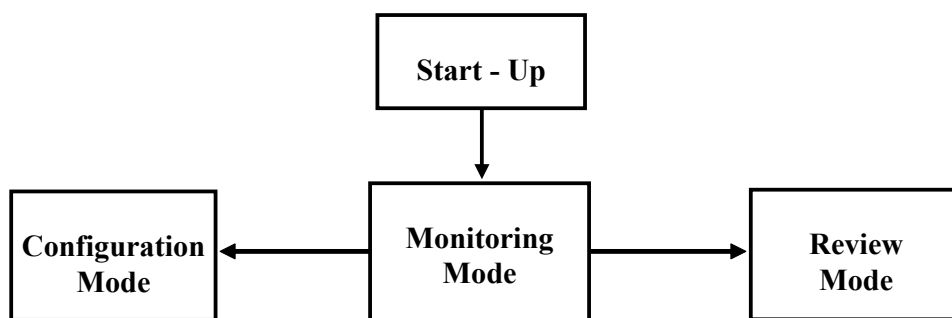

Diagram 13: Mode Structure

Further details of the information available and configuration options for the Sensepoint XCD can be found in Section 13. of this manual.

## 9 First time switch on (Commissioning)

### WARNING

*The following procedure requires the Transmitter Cover to be removed while carrying out supply voltage checks. Therefore the appropriate permits to work should be sought in preparation.*

*Prior to carrying out any HOT WORK ensure local and site procedures are followed. Ensure that the associated control panel output actuation is inhibited so as to prevent false alarms.*

*Caution: The following procedure should be followed carefully and only performed by suitably trained personnel*

**Note: Calibration is mandatory before the detector can be used for gas monitoring. Refer to Section 10.1 Calibration for the proper procedure.**

1. Remove the transmitter housing cover and detach the display unit by lifting the semi-circular handle and pulling the assembly directly away from the termination module (without twisting it)
2. The default setting is Current SOURCE.
3. Check that all electrical connections are terminated correctly as per section 6.
4. Switch On the external power supply to the transmitter at the safe area gas detection controller (or PLC).
5. Using a Digital Multi Meter (DMM), check the Supply Voltage at the terminals 1 (24V) and 2 (0V), this should be a minimum supply voltage of 18Vdc (Maximum supply voltage is 32V DC)
6. Switch Off the external power to the detector.
7. Refit the Display Module and Cover.

**Note: Ensure that none of the wires in the terminal area cause an obstruction when refitting the Display Module. Ensure that the socket on the Display Module is fully engaged in the Display Module Connector on the Terminal Module.**

**Caution: Ensure that power is removed from the Sensepoint XCD RTD transmitter when the display module is plugged into, (or unplugged from) the terminal module. Failure to remove power may cause hardware damage.**

8. Switch On external power to the detector.
9. All the display icons/text/numbers are displayed for 3 seconds.

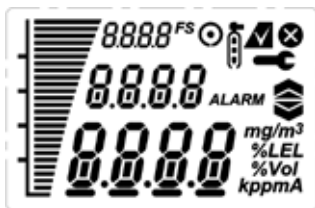

10. A start up sequence will then be displayed, similar to the one shown in Diagram 14.

**Note:**

For a full description of each screen shown in Diagram 14., please refer to Section 13.3 “Review Mode” of this Manual.

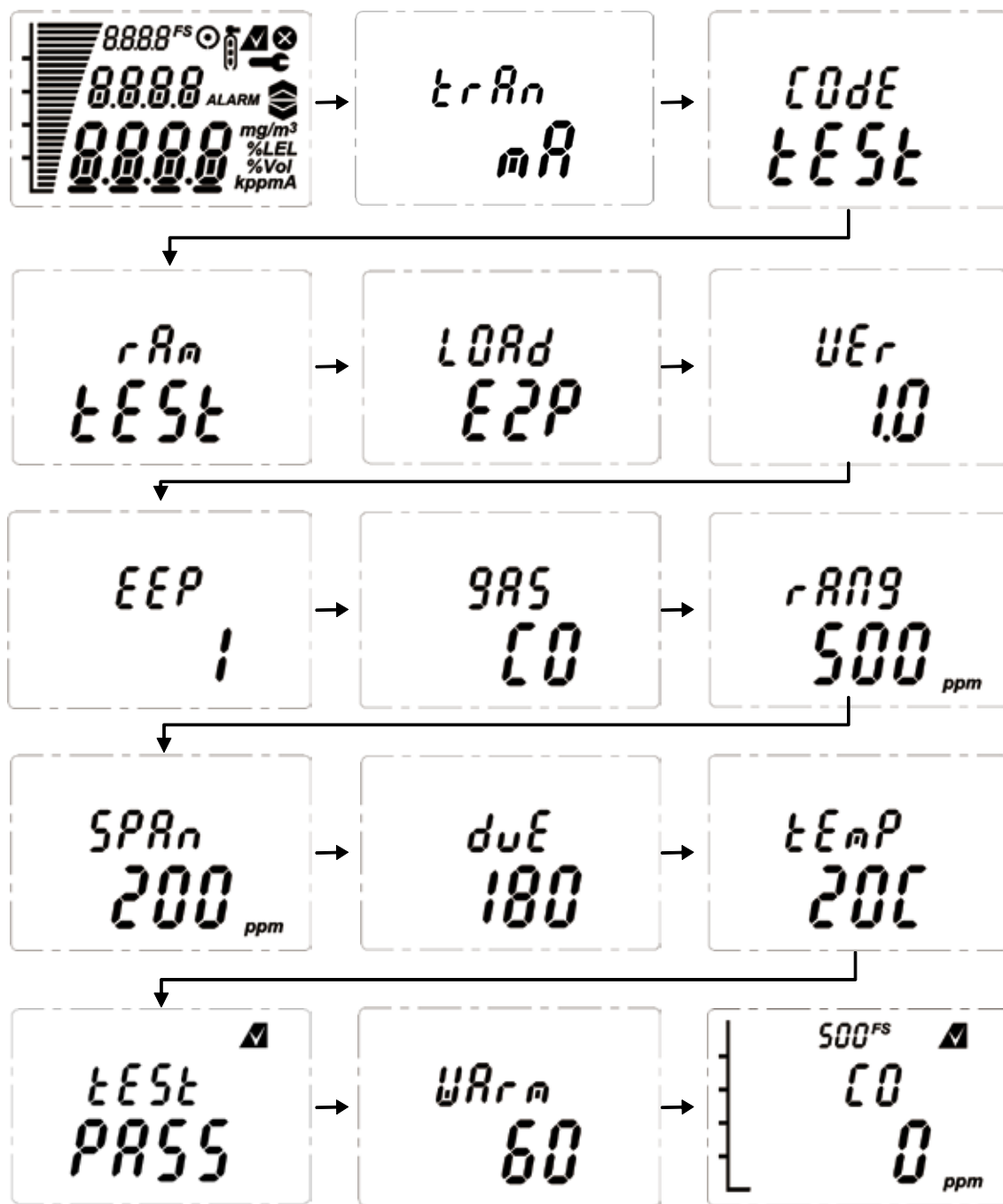

Diagram 14: Normal Start up procedure (For the CO sensor version)

11. The warm up countdown of 60 seconds (depending on the gas type) is then displayed.
12. Normal **Monitoring Mode** is then resumed.

## 9.1 Gas Selection

The Sensepoint XCD RTD Transmitter is unable to automatically “know” the type of gas sensor that is connected to it. Therefore, manual set-up of the GAS TYPE and MEASURING RANGE is required. This is done in the following way.

### 9.1.1 Gas TYPE set up

1. To access the configuration menu, hold the end of the magnet over the switch located at the top center of the XCD RTD display (✓) for at least 3 seconds, until the “confirm” ICON (●) shows on the LCD, and then remove the magnet. The display will indicate ‘SET CAL’
2. Hold the magnet over the (▲) switch for one second and remove. The display will change to ‘SEL GAS’.
3. Hold the magnet over (✓) for one second and remove. The display will change to ‘gAS CO’ (the CO part is flashing).
4. Now, with the magnet, use the (▲) or (▼) switches to scroll (one at a time) through the available gas types until the desired one is found. The available gases are listed as below.

Gas abbreviation	Gas description	Remark
NO	Nitrogen Monoxide	For use with Sensepoint Toxic range of Honeywell Analytics sensors; Default alarm levels, shown in Table 3. will be automatically set according to the measuring range selected (see section 9.1.2).
NO2	Nitrogen Dioxide	
Cl2	Chlorine	
NH3	Ammonia	
H2	Hydrogen	
SO2	Sulphur Dioxide	
CO(default)	Carbon Monoxide	
H2S	Hydrogen Sulfide	
O2	Oxygen	
User	User configurable sensor	The user should specify the target gas name, units (see section 9.1.1.1) and the measurement range (see section 9.1.2).

5. Hold the magnet over (✓) for one second and remove. The display will then show
  - a. ‘LOAd gAS’ for approx 8 seconds, followed by
  - b. ‘LOAd PASS’ for 2 seconds, followed by
  - c. ‘CAL YES’ (the ‘YES’ part is flashing).
6. Calibration should not be done until the range of the sensor has been set, hold the magnet over the (▲) or (▼) switch, the display will then show ‘CAL No’ (the ‘No’ part is flashing).

7. Hold the magnet over (✓) for one second and remove. The display will return to 'SEL GAS'.
8. Hold the magnet over the (▼) switch twice, the display will show 'Quit'. Hold the magnet over (✓) for one second and remove. The XCD RTD will return to normal Monitoring mode and the new GAS TYPE will be shown on the display.

When using a Honeywell Analytics Sensepoint Toxic sensor, go to section 9.1.2.

### 9.1.1.1 USER Gas Type set up

When a gas detector other than the Honeywell Analytics Sensepoint Toxic range of sensors is to be used with XCD RTD, please set the appropriate Unit of Measure from a pre-selected list and a 'custom' Gas Name which may be edited from 4 available alpha-numeric characters (default is 'CO'), using the following procedure:

1. Complete steps (1.) to (4.) in section 9.1.1. Until the LCD shows 'gAS User' (the User part is flashing).
2. Hold the magnet over (✓) for one second and remove. The display will show 'UNIT' and one of the units of measure will be flashing at the lower right hand side of the LCD.
3. Now with the magnet, use the (▲) or (▼) switches to scroll (one at a time) through the available units of measure until the desired one is found. The available units are listed as below.

Unit of measure	Unit Description
k	Kelvin
A	Ampere
mA	Milli ampere
kppm	Thousands of ppm
mg/m3	milligram per cubic meter
%Vol	Percent volume
ppm	Parts per million
[blank]	When there is no appropriate unit of measure available, then [blank] can be used. A 'custom' unit of measure may be printed and attached to the instrument manually

4. Hold the magnet over the (✓) switch for one second and remove. The display will then show 'NAme CO' (the first character of 'CO' has a flashing cursor under it).
5. Now with the magnet, use the (▼) switch to scroll (one at a time) through the available alpha-numeric characters until the desired one is found.
6. Hold the magnet over the (▲) switch to move the flashing cursor to the next



character and repeat step 5.

7. Once all characters are selected, hold the magnet over the (✓) switch for one second and remove. The display will return to 'SEL GAS'.
8. Hold the magnet over the (▼) switch twice, the display will show 'Quit'. Hold the magnet over the (✓) switch for one second and remove. The XCD RTD will return to normal Monitoring mode and the new GAS NAME will be shown on the display.

### 9.1.2 Gas Measuring RANGE set up

Whether a Honeywell Analytics Sensepoint Toxic sensor, or an alternative type of gas sensor is to be used with XCD RTD, the Gas Measuring Range of the sensor must be selected manually from a pre-selected list of available measuring ranges, using the following procedure:

1. To access the configuration menu, hold the end of the magnet over the switch located at the top center of the XCD RTD display (✓) for at least 3 seconds, until the "confirm" ICON (●) shows on the LCD, and then remove the magnet. The display will indicate 'SEt CAL'
2. Hold the magnet over the (▲) switch for one second and remove. The display will change to 'SEL GAS'.
3. Hold the magnet over the (▲) switch for one second and remove. The display will change to 'SEt rAng'. Hold the magnet over the (✓) switch for one second and remove.

When a gas detector other than the Honeywell Analytics Sensepoint Toxic range of sensors is to be used, go to step 6.

4. When using a Honeywell Analytics Sensepoint Toxic sensor the display will show 'rAng'. With the magnet, use the (▲) or (▼) switches to scroll (one at a time) through the available choices of gas measuring range.
5. Once the desired measuring range is showing on the display, hold the magnet over the (✓) switch for one second and remove.

Now go to step 13.

6. When a gas detector other than the Honeywell Analytics Sensepoint Toxic range of sensors is to be used, the display will then show 'dPnt' which means Decimal Point.
7. Now with the magnet, use the (▲) or (▼) switches to scroll (one at a time) through the available choices of Decimal Point positions, (choose from: 1, 0.1 or 0.01).
8. Hold the magnet over the (✓) switch for one second and remove. The display will then show 'Low 0.0' (the '0.0' (or '0' or '0.00' part is flashing). 'Low' means the lowest value in any given measuring range.

9. If the lowest (initial) value of the measuring range is at zero (for example in “0 to 100”) then do not change this value from its default of 0.
10. Once the desired lower value is showing on the display, hold the magnet over the (✓) switch for one second and remove. The display will then show ‘High 100’ (the ‘100’ part is flashing). ‘High’ means the highest value in any given measuring range.
11. Now with the magnet, use the (▲) or (▼) switches to select the desired upper value of the measuring range.
12. Once the desired upper value is showing on the display, hold the magnet over the (✓) switch for one second and remove.
13. The display will then show ‘CAL YES’ (the ‘YES’ part is flashing).
14. Now hold the magnet over (✓) for one second and remove to begin calibration of the sensor.

Go to page 32, step 5.

## 10 Response Check and Calibration

It is recommended to periodically carry out a gas response check on the Sensepoint XCD RTD to ensure correct operation. This may be done in two ways;

1. A simple Response Check often referred to as a “BUMP TEST” is a test using calibration gas applied to the sensor via the Weather Protection or using the Sensepoint Gassing Cap.

If a BUMP TEST is done via the Weather Protection it may be necessary in windy conditions to increase the flow rate of the test gas by a further 1 LPM, OR, to shelter the weather protection from the wind.

2. A full gas calibration of the sensor as described in the following section, using ONLY the Gassing Cap (PN: 2106D2097).

### 10.1 Zeroing and span calibration

**Caution: Before initial calibration allow the detector to stabilize for 30 minutes after applying power.**

**When in zeroing and span calibration mode the current output from the detector is inhibited (default 2mA) to avoid false alarms.**

To calibrate the detector, use an appropriate span gas cylinder, constant flow regulator and the Sensepoint Toxic Gassing Cap (refer to Sensepoint Technical Manual MAN0514 for details). The flow rate is used of approximately 1 to 1.5 litres per minute for calibration. Apply the gas at the flow rate for the recommended application concentration and time please see Table 6.

Gas	Range	Recommended Test Concentration	Application Time Minutes	Operating Temp. Min. Max.
H <sub>2</sub> S	0 to 20ppm	10ppm	3 mins	-20°C +50°C
H <sub>2</sub> S	0 to 50ppm	20ppm	3 mins	-20°C +50°C
H <sub>2</sub> S	0 to 100ppm	50ppm	3 mins	-20°C +50°C
CO	0 to 100ppm	50ppm	3 mins	-20°C +50°C
CO	0 to 200ppm	100ppm	3 mins	-20°C +50°C
CO	0 to 500ppm	250ppm	3 mins	-20°C +50°C
Cl <sub>2</sub>	0 to 5ppm	3ppm	10 mins	-20°C +50°C
Cl <sub>2</sub>	0 to 15ppm	10ppm	10 mins	-20°C +50°C
O <sub>2</sub>	0 to 25% V/V	19% V/V	1 min	-15°C +40°C
NH <sub>3</sub>	0 to 50ppm	25ppm	10 mins	-20°C +40°C
NH <sub>3</sub>	0 to 1000ppm	500ppm	10 mins	-20°C +40°C
H <sub>2</sub> O	to 1000ppm	500ppm	3 mins	-5°C +40°C
H <sub>2</sub> O	to 10000ppm	3000ppm	3 mins	-5°C +40°C
SO <sub>2</sub>	0 to 15ppm	10ppm	5 mins	-15°C +40°C
SO <sub>2</sub>	0 to 50ppm	20ppm	5 mins	-15°C +40°C
NO	0 to 100ppm	50ppm	5 mins	-5°C +40°C
NO <sub>2</sub>	0 to 10ppm	5ppm	5 mins	-15°C +40°C
NO <sub>2</sub>	0 to 50ppm	20ppm	5 mins	-15°C +40°C

Table 6

A compressed air cylinder (20.9%Vol oxygen) should be used to perform the zero calibration if the area where the detector is located contains any residual amount of the target gas. If no residual gas is present then the background air can be used to perform the zero calibration. Contact your Honeywell Analytics representative for details of suitable calibration kits.

To calibrate the detector follow the procedure below.

**Note: the Oxygen sensor does not require a zeroing procedure. Background air (20.9%Vol oxygen) can be used to span the oxygen sensor in place of a compressed air cylinder (20.9%Vol oxygen). For oxygen sensors only do parts 1-4, 13, 14 (if compressed air cylinder is used), 15-17 and 22 of the procedure below.**

## (ZERO CALIBRATION)

1. If the ambient air is NOT considered reliable to use to set the ZERO, then remove the weather protection and fit the Gassing Cap accessory (see Section 4.3) onto the sensor and apply a clean source of zero gas or compressed air.
2. To access the calibration menu, hold the end of the magnet over the switch located at the top center of the detector display (✓) for at least 3 seconds and then remove.
3. The display will indicate the first configuration mode menu 'Set CAL'.



4. Put the magnet over the '✓' switch again and move to enter the Calibration menu.
5. The display will show the current gas reading, and the '0' icon flashes.



6. Observe the Zero reading on the XCD RTD display. If it shows a stable reading around "0" there is no need to carry out Hardware adjustment. Skip the next step.
7. Open the sensor enclosure by unscrewing the sensor cap assembly from the sensor main body and replace with a Gassing Cap (Part No: 2106D2097) and Flow Housing. If the output, with no gas applied, is not zero then adjust the zero potentiometer through the Gassing Cap access holes (see Diagram 15) to obtain a zero indication.

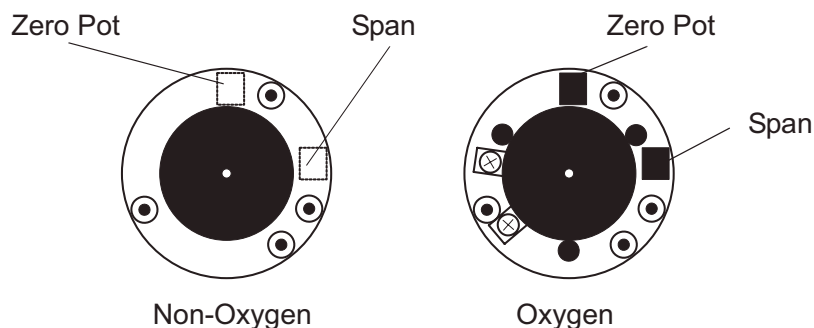

Diagram 15: Sensepoint Toxic Sensor Zero and Span potentiometer

**Note: Please refer to Section 3. (page 28) of Sensepoint Technical Manual MAN0514 for the detail procedure on how to adjust the Zero and Span potentiometer.**

8. When the zero gas reading is stable use '✓' to confirm zero calibration.
9. If successful the display shows 'ZEro PASS' (if not successful, the display shows 'ZEro FAIL' and returns to configuration mode).



10. If using zero-air, turn it off. Zeroing is complete and saved.
11. The display shows 'SPAN' with 'YES' flashing.



12. If span calibration is required use '✓' proceed to the next step. If span calibration is not required, use '▲▼' to select 'No' and '✓' to return to configuration mode.

**(SPAN CALIBRATION)**

13. The display shows the current calibration span gas concentration while flashing the 'i' icon. Use '▲▼' to change the calibration span gas concentration, and '✓' when required span calibration level is set.



14. The display will show the current gas reading, and the 'i' icon flashes.
15. Connect the regulator to the span gas cylinder. Apply gas at a flow rate of 1liter per minute for the recommended application time. (See Table 6).



**Note: This example assumes a 250ppm span gas for a 0-500ppm CO range for the whole procedure of the calibration.**

16. Apply the span gas to the sensor using the Sensepoint XCD Gassing Cap (see section 4.7 for description). The live gas reading is displayed. If the reading is around span gas concentration, there is no need to carry out any Hardware adjustment. Skip the next step.
17. Adjust the span potentiometer through the Gassing Cap access Holes (See Diagram 15) to obtain a span gas concentration indication.

18. When the reading is stable, use '✓' to confirm span calibration.
19. If the sensor has been replaced the following display may be shown.

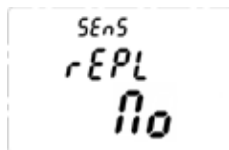

20. Use '▲▼' to select 'YES' if the sensor has been replaced or 'No' if it has not been replaced.
21. If the span calibration is successful the instrument will briefly display 'SPAN PASS' (if fails 'SPAN FAIL' displayed and returns to configuration mode).

**Note: the calibration due warning counter is reset after a successful calibration. See section 12.3 for further details of setting a calibration due warning.**



22. The display alternates between "Purg gAS" and the gas reading to indicate that the unit is expecting the span gas to be removed from the sensor.

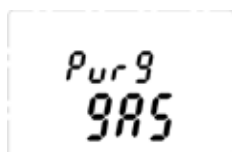

23. Promptly switch off the calibration span gas and remove the Sensepoint XCD Gassing Cap from the sensor to allow the gas to disperse.
24. When the reading falls below 50% of the calibration gas level the display indicates a countdown (up to 180 seconds dependant on gas type).

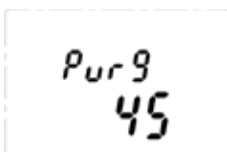

25. When the countdown is finished, the calibration procedure is complete.
26. The instrument returns to the 'Set CAL' menu. Activate the '▲' or '▼' switch to select another menu or select 'Quit' to return to normal monitoring mode.

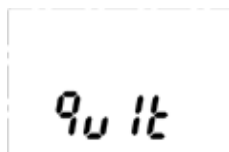

**Note: Remember to always replace the Weather Protection and other accessories.**

## 11 General Maintenance

### **WARNINGS**

***Access to the interior of the transmitter, when carrying out any work, must only be conducted by trained personnel.***

***Before carrying out any work ensure local regulations and site procedures are followed. Appropriate standards must be followed to maintain the overall certification of the sensor and transmitter.***

***To reduce the risk of ignition of hazardous atmosphere, de-classify the area or disconnect the equipment from the supply circuit before opening the transmitter enclosure. Keep assembly tightly closed during operation.***

***Never attempt to open a junction box/enclosure or replace/refit the sensor in potentially hazardous atmospheres.***

***Take care when handling sensors as they may contain corrosive solutions.***

***Do not tamper with or in any way disassemble the sensor.***

***Do not expose to temperatures outside the recommended ranges.***

***Do not expose sensors under storage conditions to organic solvents or flammable liquids.***

***At the end of their working life, replacement electrochemical sensors for oxygen and toxic gas must be disposed of in an environmentally safe manner. Disposal should be according to local waste management requirements and environmental legislation.***

***Alternatively, old replaceable sensors may be securely packaged and returned to Honeywell Analytics clearly marked for environmental disposal.***

***Electrochemical sensors should NOT be incinerated as this action may cause the cell to emit toxic fumes.***

Honeywell Analytics recommends that gas detectors are tested and re-calibrated on a six-monthly basis, or according to site practice. For Sensepoint Toxic sensors that are used either directly with XCD RTD transmitter or remotely mounted in a separate junction box, please refer to individual sensor manual for specific recommended calibration periods.

### 11.1 Operational Life

Typical life of a toxic gas sensor is dependant on the application, frequency and amount of gas exposure. Under normal conditions (3 monthly visual inspection and 6 monthly test/re-calibration), the XCD toxic sensors have an expected life equal to or greater than 24 months. The XCD Oxygen sensor has an expected life equal to or greater than 12 months.

Refer to section 12 for sensor replacement procedures.

***Caution: Oxygen deficient atmospheres (less than 6%V/V) may result in inaccuracy of reading and performance.***

## 12 Servicing

### WARNINGS

*Take care when handling sensors as they may contain corrosive solutions. Do not tamper or in any way dis-assemble the sensor. Do not expose to temperatures outside the recommended range. Do not expose sensor to organic solvents or flammable liquids.*

*At the end of their working life, replacement electrochemical sensors for oxygen and toxic gas must be disposed of in an environmentally safe manner. Disposal should be according to local waste management requirements and environmental legislation. Alternatively, old replaceable sensors may be securely packaged and returned to Honeywell Analytics clearly marked for environmental disposal.*

*Electrochemical sensors should NOT be incinerated as this action may cause the cell to emit toxic fumes.*

**Caution: The following procedure should be followed carefully and only performed by suitably trained personnel.**

**A fault condition will be signalled by the detector if the sensor is removed with the unit under power.**

### 12.1 Sensor replacement

The Sensepoint Toxic Sensor has a replaceable sensor cartridge. To replace the sensor cartridge follow the procedure below:

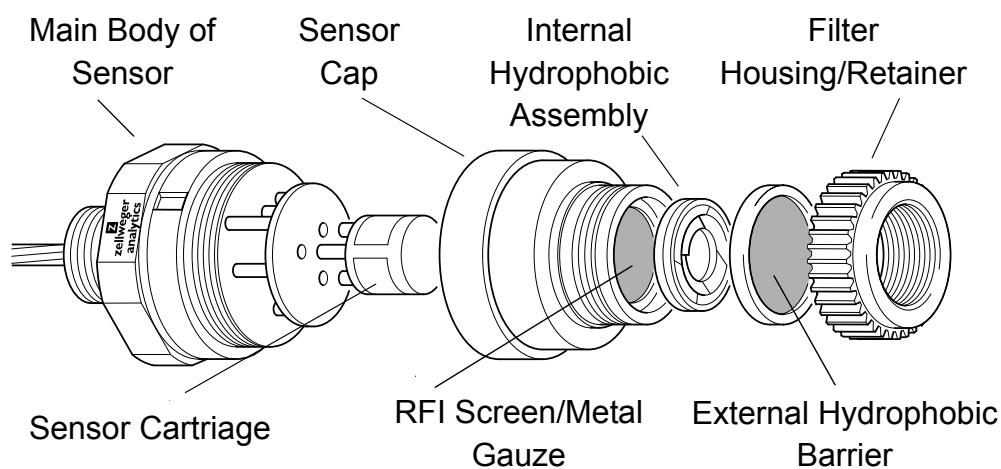

Diagram 16: Sensepoint Toxic Sensor Exploded diagram



## Replacing the Sensor Carriage

1. Unscrew and remove the filter housing/retainer (or accessory if fitted) from the sensor.
2. Remove the old internal hydrophobic assembly by pushing against the snap fit, through one of the retaining slots, with a small flat bladed screwdriver.

*The assembly will pop out.*

**Caution: Do not attempt to lever the assembly out as this may damage the housing.**

3. Remove the internal metal gauze insert.
4. Open the enclosure by unscrewing the sensor cap assembly from the sensor main body.  
Ensure that the electrochemical cell does not rotate with the cap.
5. Gently pull the old electrochemical cell from the PCB.

*See the subsequent note about replacing the Oxygen Sensor Carriage*

**Caution: Dispose of the electrochemical cell in accordance with local regulations.**

6. Remove the new cell from its packaging and remove the shorting link across the base of cell.
7. Plug the new cell into the PCB.

**Note: For Oxygen Sensepoint, unscrew the old cell connections, then screw in the new one.**

8. Screw the sensor cap assembly back onto the sensor main body.
9. Fit the new internal metal gauze assembly.
10. Fit the new internal hydrophobic assembly.

**Note: The sensor should now be calibrated. Re-calibration should only be attempted by qualified service personnel.**

11. Replace the filter housing/retainer or accessory.
12. In the event of an apparatus failure, return unit to Honeywell Analytics.

### **WARNING**

***Ensure that the same Gas Type and Range of Sensor is fitted in place of the old Sensor.***

***The manufacturer's instructions should be observed.***

## 12.2 Replacing Modules within the Transmitter

Two replaceable module assemblies are located within the transmitter housing. The Display Module and the Terminal Module.

The Display Module is simply removed by unplugging it from the Terminal Module (this procedure is done during normal installation).

To replace the Terminal Module, use the following procedure:

1. Unscrew and remove the Transmitter Cover
2. Lift the handle and un-plug and remove the Display Module.
3. Unplug the connection terminals and lift them clear of the Terminal Module.
4. Disconnect the sensor wires at the terminal block
5. Loosen and remove the three “cross-headed” screws that secure the Terminal Module to the Transmitter housing.
6. Carefully lift the Terminal Module from the transmitter housing.
7. Fit the new Terminal Module using the above procedure in reverse order.

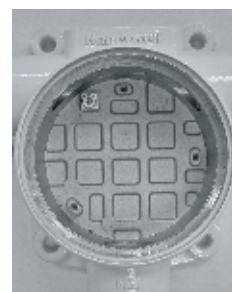
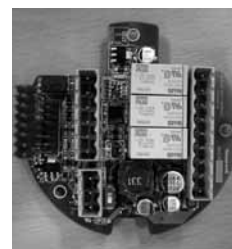
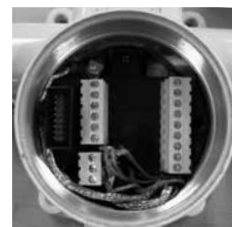

### 12.3 Faults and Warnings

The table below provides details of possible error.

Message	Description	Action
W-01	Calibration needed	The unit has not been calibrated for the configured calibration interval Calibration is necessary due to change of sensor/gas type
W-02	Transmitter Temperature limits exceeded	Use '✓' to clear when within limits
W-03	Alarm setting needs to be configured	Re-configure alarm settings such that upper alarm should not exceed user configured scale
F-01	Internal I2C failure	Cycle power to detector. Replace detector
F-02	Cell failure or Over range	Replace sensor or Check the input signal wiring.
F-03	Significant zero drift	Re zero/calibrate
F-04	Unexpected sensor fitted	Replace sensor
F-05	EEPROM is corrupted	Reset transmitter. If fault still appear, replace transmitter
F-06	Low supply voltage	Reset transmitter. If fault still appear, replace transmitter
F-07	SRS processor failure	Reset transmitter. If fault still appear, replace transmitter
F-08	RAM read/write fault	Reset transmitter. If fault still appear, replace transmitter
F-09	Info. memory corrupted	Reset transmitter. If fault still appear, replace transmitter
F-10	Code Memory corrupted	Reset transmitter. If fault still appear, replace transmitter
F-11	DAC output failure	Check load resistor or sink/source mode switch was configured properly
F-12	Heater failure	Reset transmitter. If fault still appear, replace transmitter
F-13	Supplied voltage failure	Check supply voltage. Replace detector

Table 7: Fault and Warning List

## 13 Menu's and Advanced Configuration

### 13.1 Abort Function

In Review Mode or Configuration Mode the user can escape one step back from the current position using the Abort Function. To do this the user must activate the Enter switch for more than 3 seconds with the Magnetic Wand. Switching between each pair of modes or between menus and sub menus are shown in the following table.

From	To	Example
Review Mode	Monitoring Mode	Activate Enter switch for more than 3 seconds while in Review Mode
Configuration Mode	Monitoring Mode	Activate Enter switch for more than 3 seconds while navigating menus in the Configuration Mode
Configuration Mode sub menu	Configuration Mode main menu	Activate Enter switch for more than 3 seconds while in a sub menu

Table 8: Transmitter menu switching

### 13.2 Configuration Mode

The table below shows the functions available via the configuration menu that can be displayed on the transmitter and accessed using the Magnetic Wand.











The instrument will show the main Menu when the “Enter” switch is activated with the Magnetic Wand and held for at least 3 seconds.

The Menu is password protected to prevent any unauthorized changes. The password is initially disabled and the default password is ‘0000’. If the default password is changed to other than ‘0000’, then the password is enabled automatically and requested when entering Configuration Mode.

With the Menu showing, the following functions can be performed: calibration, bump test, sensor selection and configuration of parameters such as measuring range, calibration gas level, calibration interval, inhibit current, inhibit timeout, alarm setting, relay setting, password change, location setting, temperature unit reading, force analogue output and alarm function checks.

While in Configuration mode, the output current of the transmitter is inhibited to prevent false alarms.

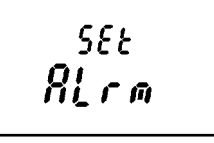
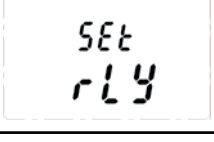
Names, displays and descriptions for each menu item in Configuration Mode are shown in the following table.

Menu	Display	Description
Set Calibration		Execute zero/span calibration Set calibration gas level After zero, the option exists to proceed with span calibration, or return to the Menu.
Select Gas		Select the type of gas from the list.
Set Range		Set measuring range
Configure Inhibit		Select inhibit current Set timeout option (5 minute increments)
Set Password		Enable/disable password Set password Default – no password (Select '0000')
Set Calibration Interval		Set calibration interval, 30 to 365 days User configurable option to display warning
Bump Test		Execute a 'bump' test to check gas response of the sensor.
Force Current		Force analogue output to test functionality of GD control system during system commissioning.
Set Alarms		Set alarm 1, alarm 2 levels, functionality and operation (none/falling/rising)
Set Relays		Set relay 1,2,3 type (alarm 1, alarm 2, fault and inhibit) and action (energized/de-energized)
Relay Operation		Configure relay on delay time, relay off delay time and latch/non-latch



Set Location		Set location (or TAG number)
Set Temperature Unit		Change temperature display unit. °C (Celcius) or °F (Fahrenheit)
Check Alarm functions		Simulate alarm situation to check the alarm system without gas present at the sensor
Quit		Return to Monitoring mode

Table 9: Transmitter menu descriptions

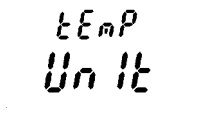

### 13.2.1 Configuration mode operation table

Configuration mode allows the user to perform calibration and configure parameters such as full scale range, calibration gas level, calibration interval, inhibit current & timeout, alarm settings, relay settings, set a password, etc. To activate Configuration mode hold the magnet over the ENTER switch for at least 3 seconds and then remove. Configuration mode can be password protected to prevent unauthorized personnel from changing parameters. Initially the password is set to '0000' meaning it is disabled. While in Configuration mode, the output current of the detector is inhibited to prevent false alarms.

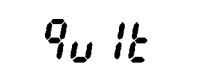
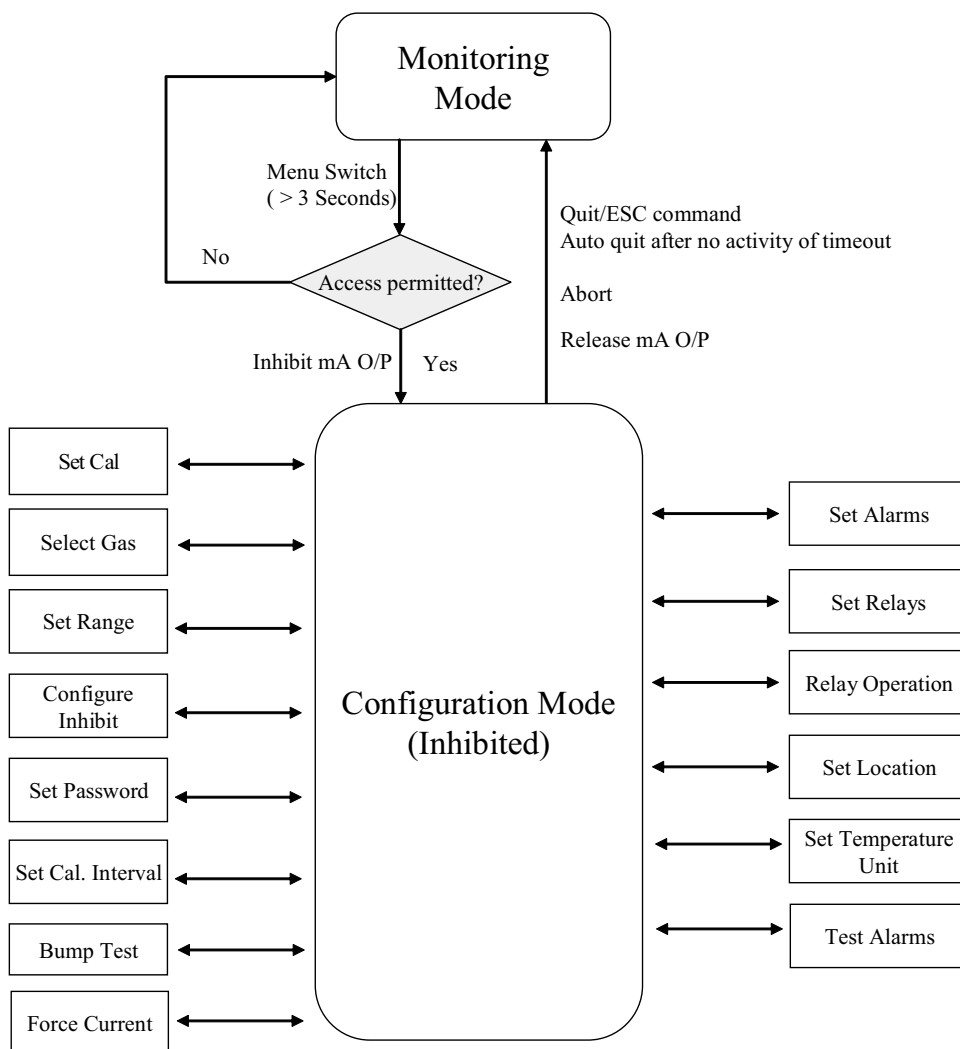
Use the table below to help navigate the menus and make configuration changes. The menus are shown in the left hand column. Use **▲▼** to select the required menu and **✓** to enter. Follow the information and instructions in the table from left to right from the required menu.

<b>▲▼</b>	<b>OK</b>	<b>▲▼</b>	<b>OK</b>	<b>▲▼</b>	<b>OK</b>	<b>▲▼</b>	<b>OK</b>	<b>▲▼</b>
<b>SEt CAL<sup>1</sup></b>	✓	GAS NAME, ZERO CONCENTRATION AND FLASHING '1' ICON DISPLAYED. APPLY ZERO GAS AND USE '✓' WHEN READING IS STABLE. IF THE READING WITH NO GAS APPLIED IS NOT ZERO THEN ADJUST THE SPAN POTENTIOMETER TO OBTAIN A ZERO GAS CONCENTRATION INDICATION.	⇨	'SPAN' DISPLAYED AND 'YES' FLASHING TO ASK IF YOU NOW WANT TO PERFORM SPAN CALIBRATION. USE '✓' TO PROCEED OR USE <b>▲▼</b> TO SELECT 'No' AND RETURN TO MENU MODE.	✓	'GAS TARGET CONCENTRATION FLASHING AND '1' ICON DISPLAYED. USE <b>▲▼</b> TO CHANGE GAS CONCENTRATION AND '✓' TO START SPAN CALIBRATION. IF THE READING WITH SPAN GAS APPLIED IS NOT SPAN READING THEN ADJUST THE SPAN POTENTIOMETER TO OBTAIN A SPAN GAS CONCENTRATION INDICATION.	✓	GAS NAME, CURRENT CONCENTRATION AND FLASHING '1' ICON DISPLAYED. APPLY SPAN GAS AND USE '✓' WHEN READING STABLE. IF OK 'Purg' DISPLAYED. REMOVE SPAN GAS. WHEN READING <50% OF SPAN POINT, COUNTDOWN BEGINS & UNIT RETURNS TO MENU MODE.
<b>SEL 9AS</b>	✓	'9AS' DISPLAYED WITH GAS TYPE DISPLAYED. USE <b>▲▼</b> TO SELECT DIFFERENT GAS.	✓	IF GAS TYPE IS CHANGED, 'CAL' YES' DISPLAYED TO ASK IF YOU NOW WANT TO PERFORM CALIBRATION. USE '✓' TO PROCEED OR USE <b>▲▼</b> TO SELECT 'No' AND RETURN TO MENU MODE.	✓			
<b>SEt rAn9</b>	✓	BAR GRAPH INDICATING CURRENT RANGE. 'An9' DISPLAYED & CURRENT RANGE FLASHES. USE <b>▲▼</b> TO SELECT DIFFERENT RANGE	✓	IF RANGE IS CHANGED, 'CAL' DISPLAYED AND 'YES' FLASHING TO ASK IF YOU NOW WANT TO PERFORM CALIBRATION. USE '✓' TO PROCEED OR USE <b>▲▼</b> TO SELECT 'No'.	✓	IF RANGE IS CHANGED, 'ALM' DISPLAYED AND 'YES' FLASHING TO ASK IF YOU NOW WANT TO MODIFY ALARM SETTINGS. USE '✓' TO PROCEED OR USE <b>▲▼</b> TO SELECT 'No' AND RETURN TO MENU MODE.		UNIT RETURNS TO MENU MODE
<b>Conf Inhb</b>	✓	'Inhb' DISPLAYED WITH 'Inhb' ICON FLASHING. CURRENT INHIBIT mA VALUE FLASHES. USE <b>▲▼</b> TO SELECT NEW VALUE (2 OR 4mA TOXICS, OR 2 OR 17.4mA OXYGEN VERSION).	✓	'time' DISPLAYED WITH 'time' ICON. FLASHING CURRENT INHIBIT TIMEOUT PERIOD (MINUTES) FLASHES. USE <b>▲▼</b> TO SET NEW TIMEOUT. (IF SET TO 0 OUTPUT IS PERMANENTLY INHIBITED)	✓			
<b>SEt PASS</b>	✓	'PASS' DISPLAYED WITH FIRST DIGIT PLACE ICON OF THE PASSCODE FLASHING. USE <b>▲</b> TO SELECT 1 <sup>st</sup> DIGIT OF CURRENT PASSWORD. USE <b>▼</b> TO MOVE TO NEXT DIGIT AND SET REST OF PASSCODE.	✓	UNIT RETURNS TO MENU MODE				
<b>Forc Curr</b>	✓	'Forc' DISPLAYED WITH 'Forc' ICON. DEFAULT FORCE CURRENT '4.00' FLASHES. USE <b>▲▼</b> TO CHANGE TO REQUIRED mA LEVEL.	✓	UNIT TRANSMITS THE CURRENT MENU. USE ABORT FUNCTION				

<b>CAL Int3</b>	✓	'Int' DISPLAYED WITH CURRENT CALIBRATION INTERVAL FLASHING. USE ▲▼ TO CHANGE INTERVAL.	✓	'dUE' DISPLAYED AND 'No', 'Lcd' OR 'ALL' FLASHING. USE ▲▼ TO SELECT REQUIRED CAL DUE WARNING OUTPUT.	✓	UNIT RETURNS TO MENU MODE	
<b>bump tEst</b>	✓	PEAK READING DISPLAYED WITH OUTPUT INHIBITED  ICON AND PEAK STRING FLASHING. APPLY BUMP TEST GAS AND CHECK PEAK READING ON DISPLAY.	✓	CURRENT GAS CONCENTRATION DISPLAYED WITH OUTPUT INHIBITED  ICON FLASHING.	✓	UNIT RETURNS TO MENU MODE WARNING: DO NOT RETURN TO NORMAL MODE UNTIL CURRENT GAS CONCENTRATION HAS FALLEN BELOW A1 LIMIT OR THE DETECTOR WILL GIVE AN ALARM	
<b>SEt ALrm</b>	✓	'AL1', ICON DISPLAYED AND CURRENT ALARM LEVEL 1 CONCENTRATION FLASHES. USE ▲▼ TO CHANGE TO REQUIRED CONCENTRATION LEVEL.	✓	'AL1' DISPLAYED WITH 'None', 'rise' OR 'FALL' FLASHING. USE ▲▼ TO SELECT REQUIRED ALARM ACTION.	✓	'AL2', ICON DISPLAYED AND CURRENT ALARM LEVEL 2 CONCENTRATION FLASHES. USE ▲▼ TO CHANGE TO REQUIRED CONCENTRATION LEVEL.	'AL2' DISPLAYED WITH 'None', 'rise' OR 'FALL' FLASHING. USE ▲▼ TO SELECT REQUIRED ALARM ACTION AND USE ✓ TO RETURN TO MENU MODE.
<b>SEt rLY</b>	✓	'rL1' DISPLAYED AND 'AL1', 'AL2', 'Inht' or 'Fl' FLASHES. USE ▲▼ TO CHANGE TO REQUIRED RELAY TARGET.	✓	'rL1' DISPLAYED AND 'eEn' or 'Emg' FLASHES. USE ▲▼ TO CHANGE TO REQUIRED RELAY ACTION.	✓	'rI2' DISPLAYED AND 'AL1', 'AL2', 'Inht' or 'Fl' FLASHES. USE ▲▼ TO CHANGE TO REQUIRED RELAY TARGET.	'rL2' DISPLAYED AND 'eEn' or 'Emg' FLASHES. USE ▲▼ TO CHANGE TO REQUIRED RELAY ACTION.
	✓	'rL3' DISPLAYED AND 'AL1', 'AL2', 'Inht' or 'Fl' FLASHES. USE ▲▼ TO CHANGE TO REQUIRED RELAY TARGET.	✓	'rL3' DISPLAYED AND 'eEn' or 'Emg' FLASHES. USE ▲▼ TO CHANGE TO REQUIRED RELAY ACTION.	✓	UNIT RETURNS TO MENU MODE	
<b>rLY OPr</b>	✓	'rLY', 'ON' DISPLAYED AND CURRENT RELAY-ON TIME FLASHES. USE ▲▼ TO CHANGE TO REQUIRED RELAY-ON DELAY.	✓	'rLY', 'OFF' DISPLAYED AND CURRENT RELAY-OFF TIME FLASHES. USE ▲▼ TO CHANGE TO REQUIRED RELAY-OFF DELAY.	✓	'Lch' DISPLAYED AND 'YES' or 'No' FLASHES. USE ▲▼ TO CHANGE TO REQUIRED LATCH OPTION.	UNIT RETURNS TO MENU MODE
<b>SEt Loc</b>	✓	'Loc' DISPLAYED WITH FIRST 4 CHARACTERS OF THE LOCATION STRING. USE ▼ TO CHANGE THE 1 <sup>ST</sup> CHARACTER OF CURRENT LOCATION STRING. USE ▲ TO MOVE TO NEXT CHARACTER AND SET REST OF STRING. MAXIMUM 12 CHARACTERS CAN BE SET.	✓	'Loc' DISPLAYED NEW LOCATION STRING. THE STRING MOVES RIGHT-TO-LEFT TO SHOW WHOLE CHARACTERS TWICE. THEN UNIT AUTOMATICALLY RETURNS TO MENU MODE.			
<b>tEmp Unlt</b>	✓	'tEmp' DISPLAYED WITH "C" OR "F" FLASHING. USE ▲▼ TO CHANGE TO REQUIRED TEMPERATURE UNIT.	✓	UNIT RETURNS TO MENU MODE			
<b>tEst ALrm</b>	✓	'Forc' DISPLAYED and 'AL1' FLASHING TO SELECT TEST-REQUIRED ALARM. USE ✓ TO FORCE ALARM1.	✓	GAS NAME, CURRENT GAS CONCENTRATION DISPLAYED AND  ICON AND AL ICON FLASHES.	✓	UNIT RETURNS TO MENU MODE	
<b>9uit</b>	✓	QUITS MENU MODE AND RETURNS TO MONITORING MODE					
<b>▲▼ OK</b>	OK	▲▼	OK	▲▼	OK	▲▼	▲▼







<sup>1</sup> Refer to section 10.1 for detailed zero and span calibration procedures. A detector fitted with an oxygen sensor will skip the zeroing  
<sup>2</sup> The calibration due warning counter is automatically reset after a successful calibration.

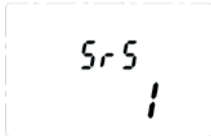

### 13.3 Review Mode

The instrument will enter Review mode when the “Enter” switch is activated with the Magnetic Wand and held for around one second.

Names, displays and descriptions for each review item in Review Mode are shown in the following table.

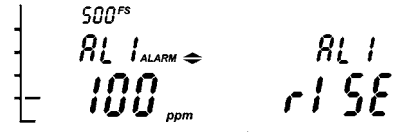
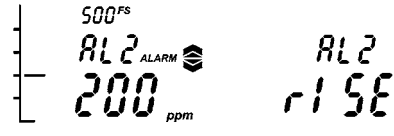
Item name	Display	Description
Software version		S/W version of transmitter
SRS version		S/W version of SRS (watch dog)
EEP version		EEPROM parameter version
Gas		Gas type
Measuring range		A user selected measuring range
Calibration level		Calibration gas level
Calibration due		Estimated time to next calibration
Alarm 1		Alarm settings for Alarm 1
Alarm 2		Alarm settings for Alarm 2







Location		Location in which the transmitter is installed
Power		Power voltage*
mA input value		mA input signal from the sensor.
Temperature		Internal Transmitter temperature*
Peak conc.		Maximum concentration detected up to now
Test Result		There is no fault detected.

Table 10: Transmitter menu descriptions

**Note:**

**\*Power voltage and internal transmitter temperature may be different from actual value due to measuring accuracy and internal heating components.**

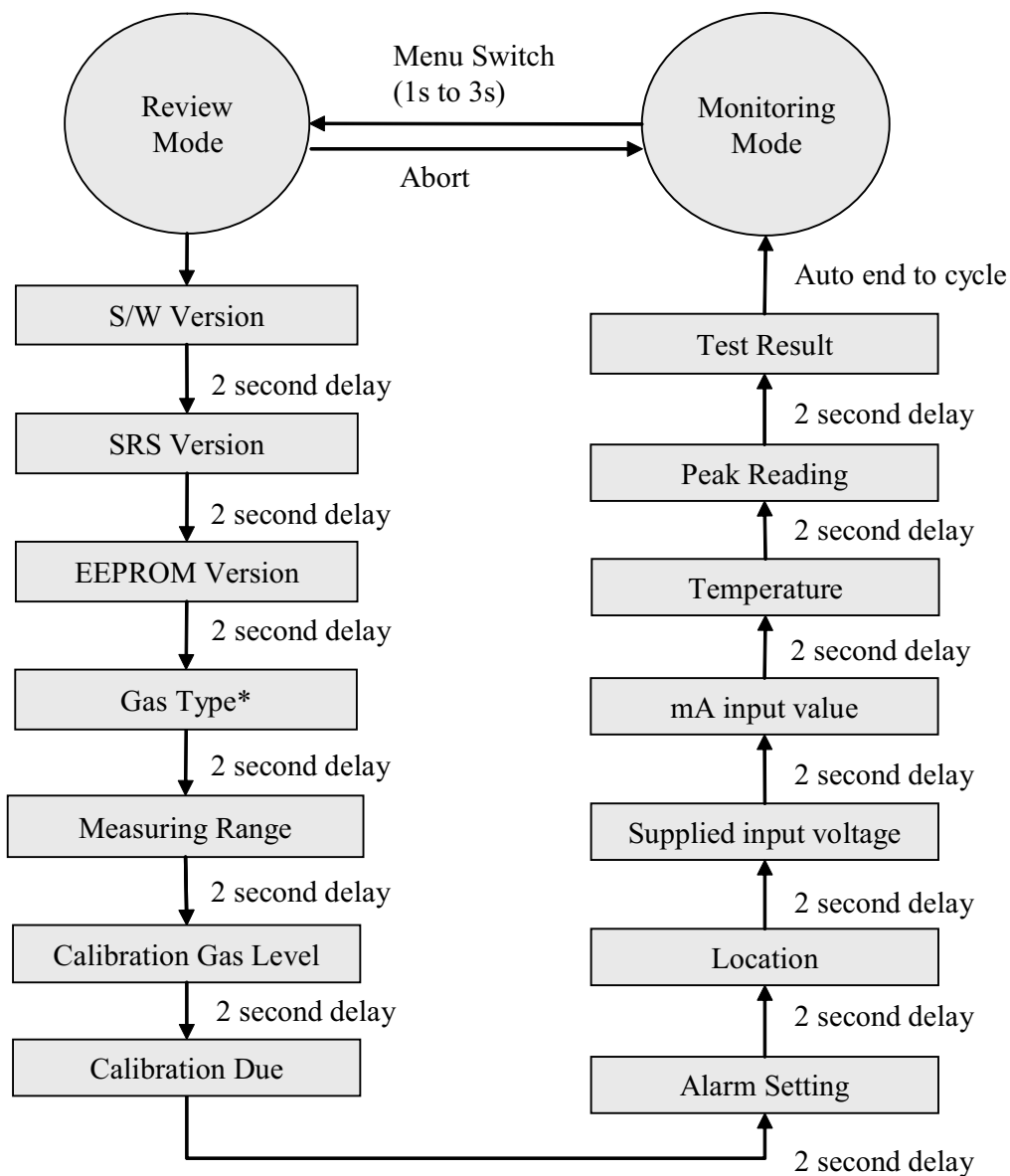

**\*Note:**  
 The default gas type is “CO” and the default measuring range is 100ppm.

Diagram 17: Review Mode

## 14 General specification

Sensepoint XCD Transmitter							
<b>Use</b>	3-wire, 4-20mA, gas detector transmitter for use with toxic gas sensors. For the protection of personnel and plant from toxic gas hazards.						
<b>Electrical</b>							
	Input Voltage Range:	18 to 32Vdc (24Vdc nominal)					
	Max Power Consumption:	Max 5 Watts. at 24Vdc (see section 2 regarding maximum in rush current)					
	Current output	4-20mA					
	≥0.0<1.0 mA	Fault (refer to table 5 section 12.3 for further details).					
	4.0 mA to 20.0 mA	Normal gas measurement					
	2.0 mA or 4.0 mA (17.4 mA)	Inhibit (during configuration/user settings)					
	22.0 mA	Maximum over range					
	Terminals	18 x screw terminals suitable for wire diameter 0.5mm <sup>2</sup> to 2.5mm <sup>2</sup> (20AWG to 13AWG).					
	Relays	3 x 5A@250VAC. Selectable normally open or normally closed (switch) and energized/de-energized (programmable).					
	Communication	RS485, Modbus RTU (Pending)					
<b>Construction</b>							
<b>Material</b>	Epoxy painted aluminium alloy or 316 Stainless Steel						
<b>Weight</b>	Aluminium alloy: 2.0kg, 316 Stainless Steel: 4.5kg						
<b>Mounting</b>	Pole or wall mounting						
<b>Entries</b>	2 x M20						
<b>Detectable Gases &amp; Performance (See notes below)</b>							
Gas Name	Displayed Name	Range	Lower Alarm	Lower Alarm Type	Higher Alarm	Higher Alarm Type	Lowest alarm level
Hydrogen Sulfide	H <sub>2</sub> S	20.0 ppm	4.0ppm	Rising	8.0ppm	Rising	2.0ppm
		50.0 ppm	10.0ppm	Rising	20.0ppm	Rising	5.0ppm
		100 ppm	20ppm	Rising	40ppm	Rising	10ppm
Carbon Monoxide	CO	100 ppm	30ppm	Rising	60ppm	Rising	10ppm
		200 ppm	40ppm	Rising	80ppm	Rising	20ppm
		500 ppm	100ppm	Rising	200ppm	Rising	50ppm
Chlorine	Cl <sub>2</sub>	5.0 ppm	0.5 ppm	Rising	2.0ppm	Rising	0.5ppm
		15.0 ppm	1.5 ppm	Rising	6.0ppm	Rising	1.5ppm
Ammonia	NH <sub>3</sub>	50.0ppm	20.0ppm	Rising	30.0ppm	Rising	5.0ppm
		100 ppm	20ppm	Rising	40ppm	Rising	10ppm
		1000 ppm	200ppm	Rising	400ppm	Rising	100ppm
Hydrogen	H <sub>2</sub>	1000ppm	200ppm	Rising	400ppm	Rising	100ppm
	H <sub>2</sub>	9999 ppm	2000ppm	Rising	4000ppm	Rising	1000ppm
Nitrogen Monoxide	NO	100 ppm	20ppm	Rising	40ppm	Rising	10ppm
Sulphur Dioxide	SO <sub>2</sub>	15.0ppm	2.0ppm	Rising	6.0ppm	Rising	1.5ppm
	SO <sub>2</sub>	50.0 ppm	5.0ppm	Rising	20.0ppm	Rising	5.0ppm
Nitrogen Dioxide	NO <sub>2</sub>	10.0 ppm	2.0ppm	Rising	4.0ppm	Rising	1.0ppm
Oxygen	O <sub>2</sub>	25.0 % V/V	19.5% Vol	Falling	23.5% Vol	Rising	10.0% Vol
<b>NOTES</b> Please refer Sensepoint Technical Handbook for detail.							
<b>Certification</b>							
China	GB Ex d IIC T4 GB3836.1&2 -2000, PA, (CCCF – Pending)						
Korea	KTL Ex d IIC T6 (-40°C to +65°C)						
European	ATEX Ex II 2 GD Ex d IIC Gb T6(Ta -40°C to +65°C) Ex tb IIIC T85°C Db IP66						
International	IEC Ex d IIC Gb T6(Ta -40°C to +65°C) Ex tb IIIC T85°C Db IP66						
CE	EN50270:2006 EN6100-6-4:2007						
<b>Environmental</b>							
<b>IP Rating</b>	IP66 in accordance with EN60529:1992						
<b>Operating Temperature</b>	-40°C to +65°C/ -40°F to +149°F Note: The detector display may become illegible at temperatures below -40°C, but the detector continues its gas monitoring function. The display is not damaged and recovers when the temperature rises back above -20 °C. Sensor operating temperature range is dependent on gas type. Please refer to the Sensepoint Technical Handbook for details.						
<b>Operating Humidity</b>	Continuous 20-90%RH (non condensing), Intermittent 10-99%RH (non condensing)						
<b>Operating Pressure</b>	90-110kPa						
<b>Storage Conditions</b>	-25°C to +65°C (-13°F to +149°F)						

## 15 Ordering information

Part Number	Description
<b>Sensepoint XCD RTD 4-20mA Input Transmitter (Select required Sensepoint Toxic Sensor from below).</b>	
SPXCDASMTX4	ATEX, IECEx & AP approved SP XCD RTD 4-20mA Input Transmitter with 316SS, M20 Entry, without MODBUS
SPXCDALMTX4	ATEX, IECEx & AP approved SP XCD RTD 4-20mA Input Transmitter with LM25, M20 Entry, without MODBUS
<b>Sensepoint Toxic Sensor</b>	
2106B1500	ATEX Approved Sensepoint H <sub>2</sub> S 0-20 ppm Toxic Sensor M25
2106B1501	ATEX Approved Sensepoint H <sub>2</sub> S 0-50 ppm Toxic Sensor M25
2106B1502	ATEX Approved Sensepoint H <sub>2</sub> S 0-100 ppm Toxic Sensor M25
2106B1505	ATEX Approved Sensepoint CO 0-100 ppm Toxic Sensor M25
2106B1506	ATEX Approved Sensepoint CO 0-200 ppm Toxic Sensor M25
2106B1507	ATEX Approved Sensepoint CO 0-500 ppm Toxic Sensor M25
2106B1510	ATEX Approved Sensepoint Cl <sub>2</sub> 0-5 ppm Toxic Sensor M25
2106B1511	ATEX Approved Sensepoint Cl <sub>2</sub> 0-15 ppm Toxic Sensor M25
2106B1513	ATEX Approved Sensepoint NH <sub>3</sub> 0-50 ppm Toxic Sensor M25
2106B1514	ATEX Approved Sensepoint NH <sub>3</sub> 0-1000 ppm Toxic Sensor M25
2106B1515	ATEX Approved Sensepoint NH <sub>3</sub> 0-100 ppm Toxic Sensor M25
2106B1516	ATEX Approved Sensepoint H <sub>2</sub> 0-1000 ppm Toxic Sensor M25
2106B1517	ATEX Approved Sensepoint H <sub>2</sub> 0-10000 ppm Toxic Sensor M25
2106B1518	ATEX Approved Sensepoint NO 0-100 ppm Toxic Sensor M25
2106B1520	ATEX Approved Sensepoint SO <sub>2</sub> 0-15 ppm Toxic Sensor M25
2106B1521	ATEX Approved Sensepoint SO <sub>2</sub> 0-50 ppm Toxic Sensor M25
2106B1522	ATEX Approved Sensepoint NO <sub>2</sub> 0-10 ppm Toxic Sensor M25
2106B1530	ATEX Approved Sensepoint O <sub>2</sub> 25% V/V Toxic Sensor M25
<b>Accessories</b>	
SPXCDMTBR	Mounting bracket (inc. bolts, nuts, brackets)
SPXCSDSP	Sunshade / Deluge Protection
<b>Spares</b>	
SPXCDTM4	Replacement terminal module for 4~20mA
SPXCDM20P	M20 blanking plug
SPXCDMANCD	Instruction manual CD
SPXCDMAG	Magnet
SPXCDAKS	Allen key for stopper
SPXCDHWES	Hex wrench for earth screw
SPXCDEBS	Earth Bracket and Screws

## 16 Warranty statement

All products are designed and manufactured to the latest internationally recognized standards by Honeywell Analytics under a Quality Management system that is certified to ISO 9001. As such Honeywell Analytics warrants its products against defective parts and workmanship and will repair or (at its option) replace any instruments which are or may become defective under proper use within 12 months from date of commissioning by an approved Honeywell Analytics representative or 18 months from date of shipment from Honeywell Analytics, whichever is the sooner. This warranty does not cover disposable batteries or damage caused by accident, abuse, abnormal operating conditions or poisoning of sensor.

Defective goods must be returned to Honeywell Analytics premises accompanied by a detailed description of any issue. Where return of goods is not practicable Honeywell Analytics reserves the right to charge for any site attendance where any fault is not found with the equipment. Honeywell Analytics shall not be liable for any loss or damage whatsoever or howsoever occasioned which may be a direct or indirect result of the use or operation of the Contract Goods by the Buyer or any Party.

This warranty covers instrument and parts sold to the Buyer only by authorized distributors, dealers and representatives as appointed by Honeywell Analytics. The warranties set out in this clause are not pro rata, i.e. the initial warranty period is not extended by virtue of any works carried out there under.

In no event will Honeywell Analytics be liable for any incidental damages, consequential damages, special damages, punitive damages, statutory damages, indirect damages, loss of profits, loss of revenues, or loss of use, even if informed of the possibility of such damages. Honeywell Analytic's liability for any claims arising out of or related to this product will in no case exceed the order value. To the extent permitted by applicable law, these limitations and exclusions will apply regardless of whether liability arises from breach of contract, warranty, tort (including but not limited to negligence), by operation of law, or otherwise.

# 17 Installation Drawing

## 17.1 Mechanical Installation Drawing

**Vertical Pipe Mounted**

**Horizontal Pipe Mounted**

**Wall Mounted**

THIS DOCUMENT HAS BEEN GENERATED USING AutoCAD AND MUST ONLY BE UPDATED BY C.A.D.

SHT. 1

**3001G0496**

**I. SPECIFICATION**  
 1. SIZE: 164 X 217 X 99  
 2. MATERIAL  
 A. TRANSMITTER: LM25 / 316SS  
 B. MOUNTING BRACKET: 316SS  
 3. WEIGHT: 2kg / 4.5kg  
 A. TRANSMITTER(LM25): 1.8kg  
 B. TRANSMITTER(316SS): 4.3kg  
 C. MOUNTING BRACKET: 0.2kg

**II. HAZARDOUS CERTIFICATION**  
 1. ATEX  
 II 2 GD  
 Ex d IIC Gb T6(Ta -40 °C to +65 °C)  
 Ex tb IIIC T85 °C Db IP66  
 Baseefa08ATEX0222  
 2. KTL  
 Ex d IIC T6, 16~32Volts DC, Pmax=5W  
 Tamb. -40 °C to +65 °C  
 3. GB, PA

**III. ITEM LIST**  
 1. XCD RTD TRANSMITTER  
 2. SENSE POINT TOXIC DETECTOR  
 3. PIPE MOUNTING BRACKET

ALL DIMENSIONS IN MILLIMETRES UNLESS OTHERWISE STATED. AND APPLY AFTER PLATING  
 THIS DRAWING IS TO BS 8888  
 REMOVE ALL BURRS AND SHARP EDGES  
 SURFACE TEXTURE VALUES ARE IN um Ra AND TO BS 1134

FINISH

I	H	G	F	E	D	C	B	A
13NOV09	12NOV09	09NOV09	06NOV09	02NOV09	23OCT09	27OCT09	08OCT09	17JUL09
Change V	Change V	Change V	Change V	Modify Text	Remove Adapter	Change Title	Add Sheet4	New Drawing
J.Y.	JIN	J.Y.	JIN	J.Y.	JIN	J.Y.	JIN	J.Y.

TOLEANCES TO BE AS SPECIFIED BELOW UNLESS OTHERWISE STATED.  
 DIMS. 1. DP ± 0.25 mm  
 NONE ± 0.4 mm  
 ANGULAR ± 1/2 °  
 HOLES. Ø 0 to 8 + 0.08  
 Ø 8 to 14 + 0.1  
 Ø 14 to 25 + 0.12  
 Ø 25 to 50 + 0.2

THIS DRAWING IS CONFIDENTIAL. IT IS THE PROPERTY OF HONEYWELL ANALYTICS LTD AND MUST NOT BE REPRODUCED EITHER WHOLLY OR PARTLY. ALL RIGHTS IN RESPECT OF PATENTS, DESIGNS AND COPYRIGHT ARE RESERVED.

THIS ITEM FORMS PART OF A CERTIFIED PRODUCT NO MODIFICATION PERMITTED WITHOUT REFERENCE TO CERTIFICATION DEPARTMENT

SCALE: SA 17-JUL-09  
 TITLE: Sensepoint XCD RTD Transmitter Installation Drawing  
 3001G0496

SHT. 1 OF 4

### 17.2 Electronic Connection Drawing

**3001G0496** SHT. 2

THIS DOCUMENT HAS BEEN GENERATED USING AutoCAD AND MUST ONLY BE UPDATED BY C.A.D.

#### Controller & Transmitter

**3 Wire 4~20mA (Source) with Relays**

**3 Wire 4~20mA (Sink) with Relays**

TRANSMITTER CONNECTION	
TERMINAL NO.	FUNCTION
1	+24V DC (18~32VDC)
2	0 V
3	4~20mA (signal)
4	TBD
5	TBD
6	TBD
7	RLY 1 NC
8	RLY1 COM
9	RLY 1 NO
10	RLY 2 NC
11	RLY2 COM
12	RLY NO
13	RLY3 NC
14	RLY 3 COM
15	RLY 3 NO
16	+24V DC
17	4~20mA (signal)
18	0 V

**NOTES:**

- REFER TO INSTRUCTION MANUAL FOR TECHNICAL DETAILS.
- XCD OPERATING VOLTAGE 18~32Volts DC, 5W(Max)
- 4~20 mA LOOP RESISTANCE TO BE < 300 ohms
- POWER SUPPLY LOOP RESISTANCE TO BE < 12 ohm
- NO TWO 'EARTGH POINTS' SHOULD BE CONNECTED VIA SCREEN AND/OR CONDUIT SO AS TO AVOID 'GROUND LOOPS'.
- MULTIPLE 'EARTH POINTS' ARE NOT ALLOWED.
- '(G) POINTS' (CONTINUITY OF SCREEN) MAY BE ACHIEVED USING APPROPRIATE GLANDS/CABLE OR CONDUIT; INTERNAL AND EXTERNAL 'EARTH POINTS' IN THE TRANSMITTER ARE PROVIDED.

<p>THIS DRAWING IS CONFIDENTIAL. IT IS THE PROPERTY OF HONEYWELL ANALYTICS LTD AND MUST NOT BE REPRODUCED EITHER WHOLLY OR PARTLY. ALL RIGHTS IN RESPECT OF PATENTS, DESIGNS AND COPYRIGHT ARE RESERVED.</p>	<p>TOLEANCES TO BE AS SPECIFIED BELOW UNLESS OTHERWISE STATED.</p> <p>DIMS.</p> <p>2 DP ± 0.1 mm</p> <p>1 DP ± 0.25 mm</p> <p>NONE ± 0.4 mm</p> <p>ANGULAR ± 1/2°</p> <p>HOLES.</p> <p>∅ 0 to 8 + 0.08</p> <p>∅ 8 to 14 + 0.1</p> <p>∅ 14 to 25 + 0.12</p> <p>- 0.0</p>
<p>ALL DIMENSIONS IN MILLIMETRES UNLESS OTHERWISE STATED, AND APPLY AFTER PLATING.</p> <p>THIS DRAWING IS TO BS 8888</p> <p>REMOVE ALL BURRS AND SHARP EDGES</p> <p>SURFACE TEXTURE VALUES ARE IN µm Ra AND TO BS 1134</p>	
<p>FINISH</p>	
<p>MATERIAL</p>	
<p>SCALE: NTS</p>	
<p>DRN: SA</p>	
<p>TITLE: Sensepoint XCD RTD Transmitter Installation Drawing</p>	
<p>3001G0496</p>	
<p>DATE: 17/JUL/09</p>	
<p>ISSUE: A</p>	
<p>CHANGE: New Drawing</p>	
<p>APPD: J.J.JIN</p>	
<p>APP'D: J.J.JIN</p>	
<p>ADD SHEET: .SHT.2</p>	
<p>OF 4</p>	





3001G0496 SHT. 3  
THIS DOCUMENT HAS BEEN GENERATED USING AutoCAD AND MUST ONLY BE UPDATED BY C.A.D.

# Transmitter & Detector

2 Wire 4~20mA (Source)

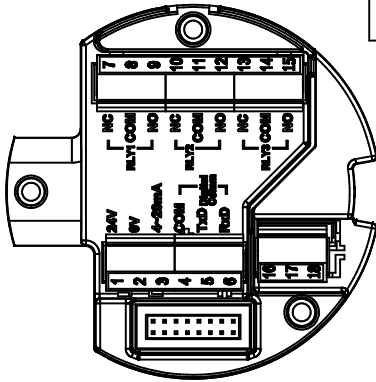
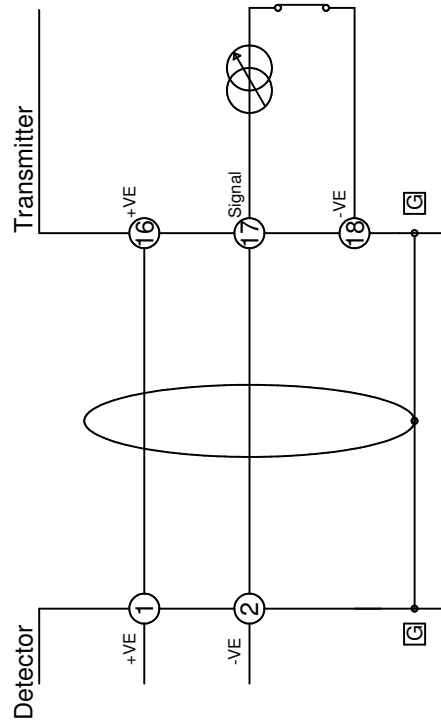

TERMINAL NO.	FUNCTION
1	+24V DC (18~32VDC)
2	0 V
3	4~20 mA (signal)
4	TBD
5	TBD
6	TBD
7	RLY1 NC
8	RLY1 COM
9	RLY1 NO
10	RLY2 NC
11	RLY2 COM
12	RLY2 NO
13	RLY3 NC
14	RLY3 COM
15	RLY3 NO
16	+24V DC
17	4~20 mA
18	-

THIS ITEM FORMS PART OF A CERTIFIED PRODUCT  
NO MODIFICATION PERMITTED WITHOUT  
REFERENCE TO CERTIFICATION DEPARTMENT

- NOTES:
- REFER TO INSTRUCTION MANUAL FOR TECHNICAL DETAILS.
  - XCD OPERATING VOLTAGE 18~32volts DC, 5W(Max)
  - 4~20 mA LOOP RESISTANCE TO BE < 300 ohms
  - POWER SUPPLY LOOP RESISTANCE TO BE < 12 ohm
  - NO TWO 'EARTH POINTS' SHOULD BE CONNECTED VIA SCREEN AND/OR CONDUIT SO AS TO AVOID 'GROUND LOOPS'.
  - MULTIPLE 'EARTH POINTS' ARE NOT ALLOWED.
  - '[G] POINTS' (CONTINUITY OF SCREEN) MAY BE ACHIEVED USING APPROPRIATE GLANDS/CABLE OR CONDUIT; INTERNAL AND EXTERNAL 'EARTH POINTS' IN THE TRANSMITTER ARE PROVIDED.

TOLERANCES TO BE AS SPECIFIED BELOW UNLESS OTHERWISE STATED.		FINISH																																																			
DIMS:	2 DP ± 0.1 mm HOLE ± 0.25 mm NOSE ± 0.4 mm ANGULAR ± 1/2	ALL DIMENSIONS IN MILLIMETRES (UNLESS OTHERWISE STATED, AND APPLY AFTER PLATING)	THIS DRAWING IS TO BS 8888																																																		
HOLE:	Ø 0 to 8 + 0.08 Ø 8 to 14 + 0.1 Ø 14 to 25 + 0.12	REMOVE ALL BURRS AND SHARP EDGES	SURFACE TEXTURE VALUES ARE IN µm Ra AND TO BS 1134																																																		
IT IS THE PROPERTY OF HONEYWELL ANALYTICS LTD AND MUST NOT BE REPRODUCED EITHER WHOLLY OR PARTLY. ALL RIGHTS IN RESPECT OF PATENTS, DESIGNS AND COPYRIGHT ARE RESERVED.		<table border="1"> <tr> <th>SCALE</th> <th>DR/PN</th> <th>TITLE</th> </tr> <tr> <td>NTS</td> <td>SA</td> <td>17-JUL-09</td> </tr> <tr> <td colspan="3">Sensepoint XCD RTD Transmitter Installation Drawing</td> </tr> <tr> <td colspan="3">3001G0496</td> </tr> </table>		SCALE	DR/PN	TITLE	NTS	SA	17-JUL-09	Sensepoint XCD RTD Transmitter Installation Drawing			3001G0496																																								
SCALE	DR/PN	TITLE																																																			
NTS	SA	17-JUL-09																																																			
Sensepoint XCD RTD Transmitter Installation Drawing																																																					
3001G0496																																																					
<table border="1"> <tr> <th>ISSUE</th> <th>DATE</th> <th>CHANGE</th> </tr> <tr> <td>A</td> <td>17/JUL/09</td> <td>New Drawing</td> </tr> <tr> <td>B</td> <td>08/OCT/09</td> <td>Add Sheet</td> </tr> <tr> <td>C</td> <td>27/OCT/09</td> <td>Remove Adapter Title</td> </tr> <tr> <td>D</td> <td>29/OCT/09</td> <td>Change Text</td> </tr> <tr> <td>E</td> <td>02/NOV/09</td> <td>Modify Note</td> </tr> <tr> <td>F</td> <td>08/NOV/09</td> <td>Change V Range</td> </tr> <tr> <td>G</td> <td>09/NOV/09</td> <td>Change V Range</td> </tr> <tr> <td>H</td> <td>12/NOV/09</td> <td>Change V Range</td> </tr> <tr> <td>I</td> <td>13/NOV/09</td> <td>Change V Range</td> </tr> </table>		ISSUE	DATE	CHANGE	A	17/JUL/09	New Drawing	B	08/OCT/09	Add Sheet	C	27/OCT/09	Remove Adapter Title	D	29/OCT/09	Change Text	E	02/NOV/09	Modify Note	F	08/NOV/09	Change V Range	G	09/NOV/09	Change V Range	H	12/NOV/09	Change V Range	I	13/NOV/09	Change V Range	<table border="1"> <tr> <th>APP'D</th> <th>JIN</th> <th>JIN</th> <th>JIN</th> <th>JIN</th> <th>JIN</th> <th>JIN</th> <th>JIN</th> <th>JIN</th> <th>JIN</th> </tr> <tr> <td>J.Y.</td> <td>J.Y.</td> <td>J.Y.</td> <td>J.Y.</td> <td>J.Y.</td> <td>J.Y.</td> <td>J.Y.</td> <td>J.Y.</td> <td>J.Y.</td> <td>J.Y.</td> </tr> </table>		APP'D	JIN	JIN	JIN	JIN	JIN	JIN	JIN	JIN	JIN	J.Y.	J.Y.	J.Y.	J.Y.	J.Y.	J.Y.	J.Y.	J.Y.	J.Y.	J.Y.
ISSUE	DATE	CHANGE																																																			
A	17/JUL/09	New Drawing																																																			
B	08/OCT/09	Add Sheet																																																			
C	27/OCT/09	Remove Adapter Title																																																			
D	29/OCT/09	Change Text																																																			
E	02/NOV/09	Modify Note																																																			
F	08/NOV/09	Change V Range																																																			
G	09/NOV/09	Change V Range																																																			
H	12/NOV/09	Change V Range																																																			
I	13/NOV/09	Change V Range																																																			
APP'D	JIN	JIN	JIN	JIN	JIN	JIN	JIN	JIN	JIN																																												
J.Y.	J.Y.	J.Y.	J.Y.	J.Y.	J.Y.	J.Y.	J.Y.	J.Y.	J.Y.																																												

17.3 Sensepoint XCD RTD Typical Installation Drawing

**3001G0496**

SHT. 4

THIS DOCUMENT HAS BEEN GENERATED USING AutoCAD  
AND MUST ONLY BE UPDATED BY C.A.D.

The drawing shows a Honeywell Sensepoint XCD RTD transmitter. The front view (top) shows a circular device with two M20 ports and a central cable connection. The side view (bottom) shows the rectangular housing with four mounting holes and a cable connector. The cable is shown connecting the two views. The Honeywell logo is visible on both views.

THIS ITEM FORMS PART OF A CERTIFIED PRODUCT  
NO MODIFICATION PERMITTED WITHOUT  
REFERENCE TO CERTIFICATION DEPARTMENT

SCALE		DR/N		SA		17-Jul-09	
NTS		TITLE		Sensepoint XCD RTD Transmitter Installation Drawing		3001G0496 SHT.4 OF 4	
A	B	C	D	E	F	G	H
17/JUL/09	08/OCT/09	27/OCT/09	02/NOV/09	12/NOV/09	06/NOV/09	09/NOV/09	13/NOV/09
New Drawing	Add Sheet	Change Title	Remove Adaptor	Modify Text	Change Note	Change Range	Change V Range
J.Y.JIN	J.Y.JIN	J.Y.JIN	J.Y.JIN	J.Y.JIN	J.Y.JIN	J.Y.JIN	J.Y.JIN
MATERIAL		FINISH		TOLERANCES TO BE AS SPECIFIED BELOW UNLESS OTHERWISE STATED.		ALL DIMENSIONS IN MILLIMETRES UNLESS OTHERWISE STATED. AND APPLY AFTER PLATING.	
				DIMS. 2 DP ± 0.1 mm 1 DP ± 0.25 mm NONE ± 0.4 mm ANGULAR ± 1/2°		THIS DRAWING IS TO BS 8888  REMOVE ALL BURRS AND SHARP EDGES  SURFACE TEXTURE VALUES ARE IN µm Ra AND TO BS 1134	
				HOLES: Ø 0 to 8 + 0.08 - 0.0 Ø 8 to 14 + 0.1 - 0.0 Ø 14 to 25 + 0.12 - 0.0			
				THIS DRAWING IS CONFIDENTIAL. IT IS THE PROPERTY OF HONEYWELL ANALYTICS LTD AND MUST NOT BE REPRODUCED EITHER WHOLLY OR PARTLY. ALL RIGHTS IN RESPECT OF PATENTS, DESIGNS AND COPYRIGHT ARE RESERVED.			

17.4 Mounting Bolt Assy Drawing

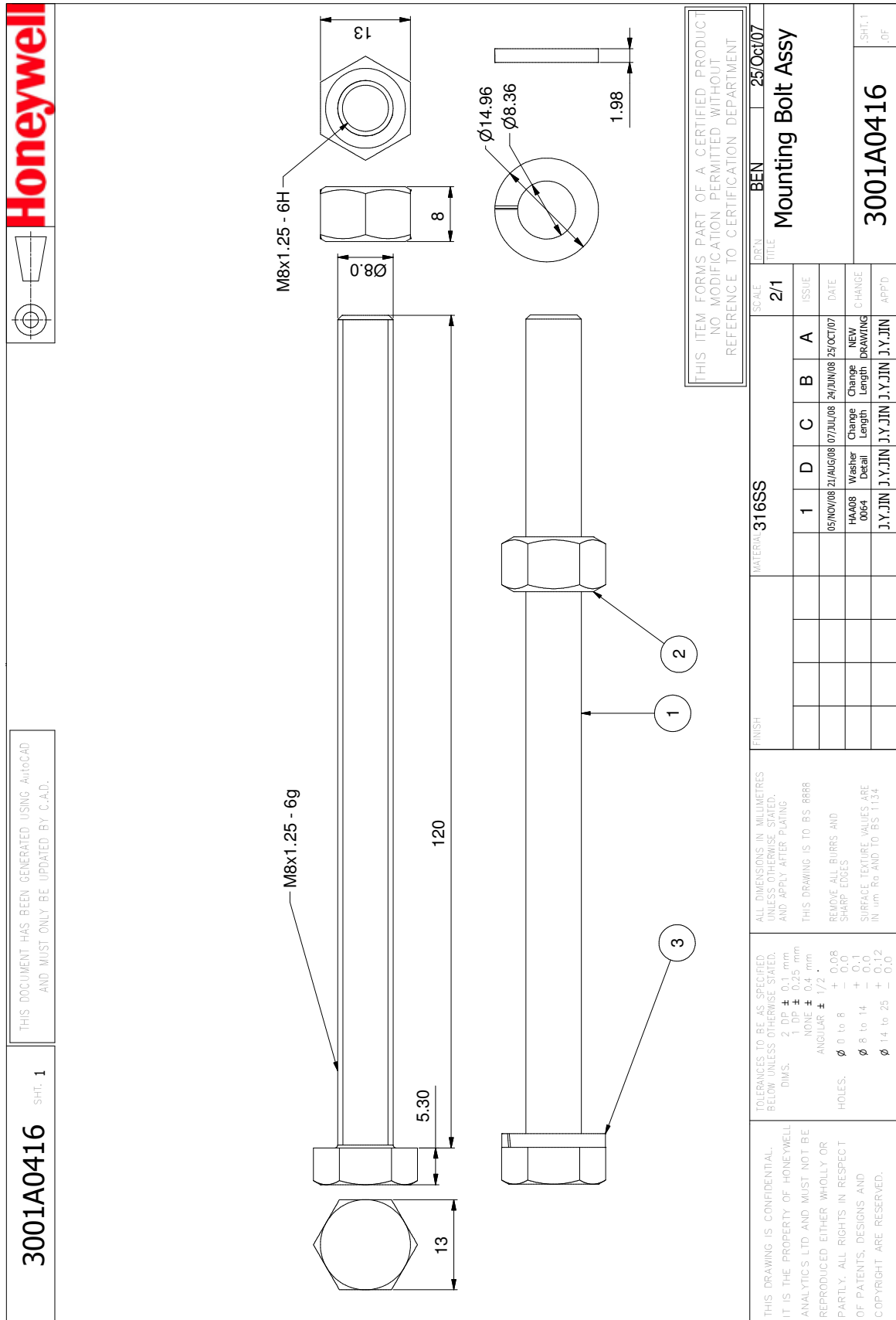

17.5 Mounting Bracket Drawing

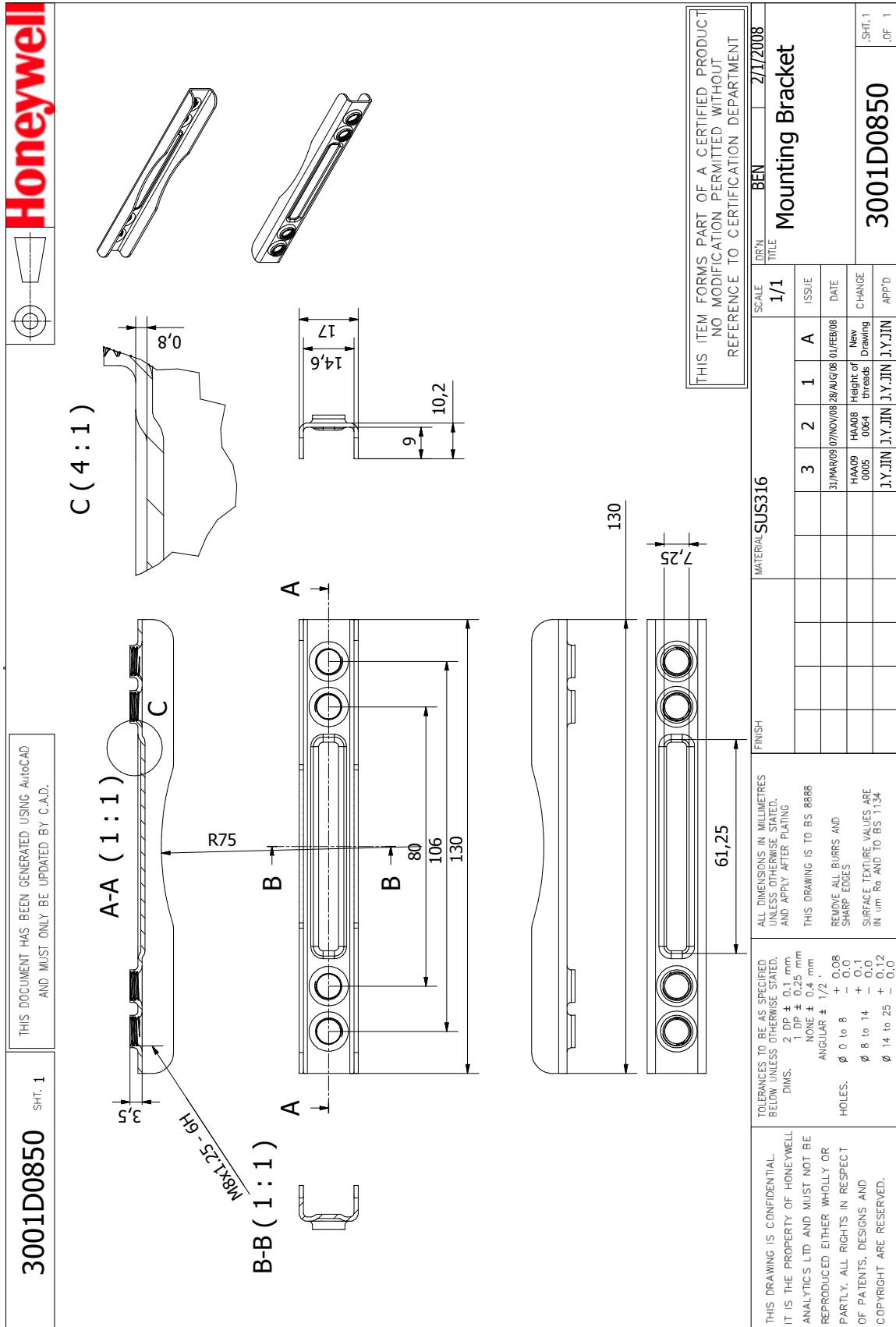

## 18 Certification

### 18.1 China GB Ex and PA

China GB Ex (Chinese Version):



# 防 爆 合 格 证

证号: GYJ081072X

由 **霍尼韦尔探测器亚太有限公司** 制造的产品:  
(地址: 508 Korea Science Valley(H) 187-10 Guro-dong, Guro-Gu Seoul, 152-050, Korea)

名 称 **可燃气体探测器**

型号规格 **Sensepoint XCD**

防爆标志 **Ex d IIC T4**

产品标准 /

图样编号 **3001EG026、3001EG027**

经图样及技术文件的审查和样品检验, 确认上述产品符合 **GB 3836.1-2000、GB 3836.2-2000** 标准, 特颁发此证。有效期自颁发日期起 **伍** 年内有效。

备注 产品使用安全注意事项见防爆合格证附件 I。

站长 

国家级仪器仪表防爆安全监督检验站

颁发日期 **二〇〇八** 年 **七** 月 **十五** 日

本证书仅对与认可文件和样品一致的产品有效。

地址: 上海市漕宝路103号  
邮编: 200233

网址: www.nepsi.org.cn  
Email: info@nepsi.org.cn

电话: 0086 21 64568180  
传真: 0086 21 64544580

China GB Ex (English Version):

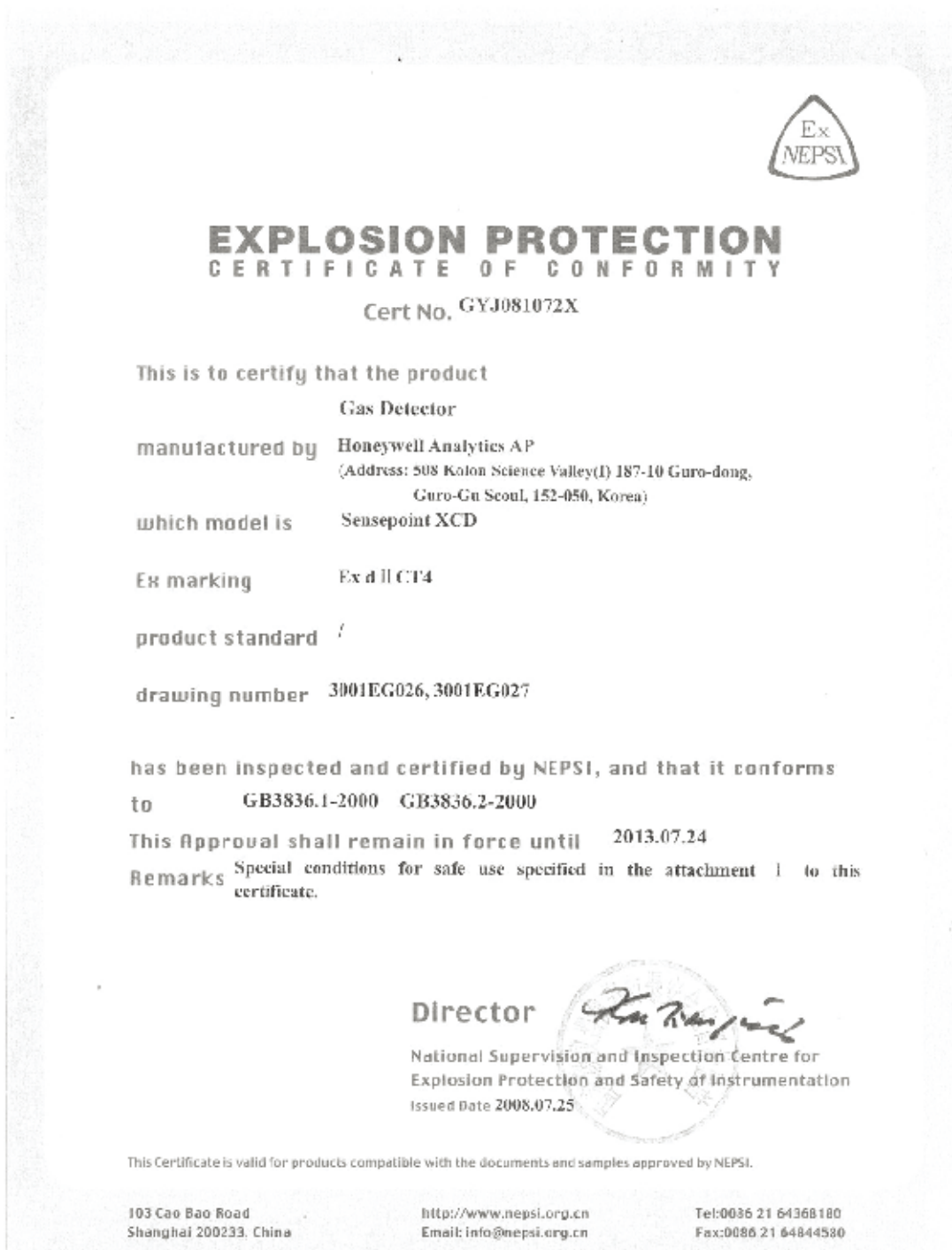

China PA Certification:

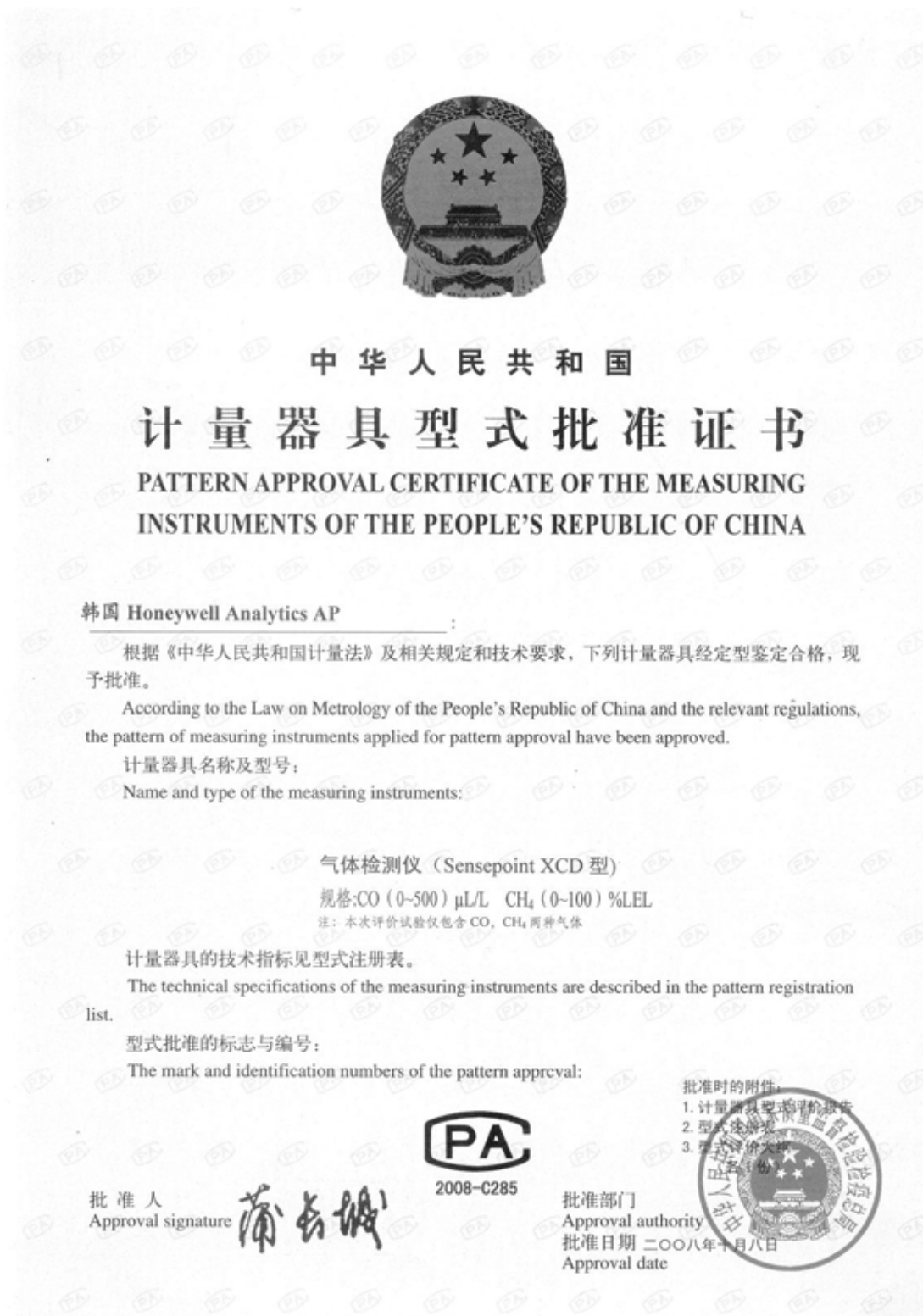

中华人民共和国

# 计量器具型式批准证书

## PATTERN APPROVAL CERTIFICATE OF THE MEASURING INSTRUMENTS OF THE PEOPLE'S REPUBLIC OF CHINA

韩国 Honeywell Analytics AP \_\_\_\_\_ :

根据《中华人民共和国计量法》及相关规定和技术要求,下列计量器具经定型鉴定合格,现予批准。

According to the Law on Metrology of the People's Republic of China and the relevant regulations, the pattern of measuring instruments applied for pattern approval have been approved.

计量器具名称及型号:

Name and type of the measuring instruments:

气体检测仪 (Sensepoint XCD 型)

规格:CO (0-500)  $\mu$ L/L CH<sub>4</sub> (0-100) %LEL

注:本次评价试验仅包含 CO, CH<sub>4</sub> 两种气体

计量器具的技术指标见型式注册表。

The technical specifications of the measuring instruments are described in the pattern registration list.

型式批准的标志与编号:

The mark and identification numbers of the pattern approval:



2008-C285

批准人  
Approval signature

批准部门  
Approval authority  
批准日期 二〇〇八年十月八日  
Approval date

批准时的附件:

1. 计量器具型式评价报告
2. 型式注册表
3. 型式评价大纲



18.2 Korea KTL





### 18.3 European ATEX

ATEX For Transmitter:

Certificate Number  
Baseefa08ATEX0222/1



Issued 3 December 2009  
Page 1 of 2

1 **SUPPLEMENTARY EC - TYPE EXAMINATION CERTIFICATE**

2 **Equipment or Protective System Intended for use in Potentially Explosive Atmospheres  
Directive 94/9/EC**

3 Supplementary EC - Type Examination Certificate Number: **Baseefa08ATEX0222/1**

4 Equipment or Protective System: **A Type XCD Transmitter**

5 Manufacturer: **Honeywell Analytics**

6 Address: **405 Barclay Boulevard, Lincolnshire, Illinois, 60069 USA**

7 This supplementary certificate extends EC – Type Examination Certificate No. **Baseefa08ATEX0222** to apply to equipment or protective systems designed and constructed in accordance with the specification set out in the Schedule of the said certificate but having any variations specified in the Schedule attached to this certificate and the documents therein referred to.

This supplementary certificate shall be held with the original certificate.

This certificate may only be reproduced in its entirety, without any change, schedule included.

Baseefa Customer Reference No. **5989**

Project File No. **09/0936**

This certificate is granted subject to the general terms and conditions of Baseefa. It does not necessarily indicate that the equipment may be used in particular industries or circumstances.

**R S SINCLAIR**  
DIRECTOR  
On behalf of  
Baseefa

**Baseefa**  
Rockhead Business Park, Staden Lane,  
Buxton, Derbyshire SK17 9RZ  
Telephone +44 (0) 1298 766600 Fax +44 (0) 1298 766601  
e-mail [info@baseefa.com](mailto:info@baseefa.com) web site [www.baseefa.com](http://www.baseefa.com)  
Baseefa is a trading name of Baseefa Ltd  
Registered in England No. 4305578. Registered address as above.

## ATEX Original Certificate For Transmitter:

Certificate Number  
Baseefa08ATEX0222



Issued 31 October 2008  
Page 1 of 2

- 1 **EC - TYPE EXAMINATION CERTIFICATE**
- 2 **Equipment or Protective System Intended for use in Potentially Explosive Atmospheres  
Directive 94/9/EC**
- 3 EC - Type Examination Certificate Number: **Baseefa08ATEX0222**
- 4 Equipment or Protective System: **A Type XCD Transmitter**
- 5 Manufacturer: **Honeywell Analytics**
- 6 Address: **405 Barclay Boulevard, Lincolnshire, IL 60069, USA.**
- 7 This equipment or protective system and any acceptable variation thereto is specified in the schedule to this certificate and the documents therein referred to.
- 8 Baseefa, Notified Body number 1180, in accordance with Article 9 of the Council Directive 94/9/EC of 23 March 1994, certifies that this equipment or protective system has been found to comply with the Essential Health and Safety Requirements relating to the design and construction of equipment and protective systems intended for use in potentially explosive atmospheres given in Annex II to the Directive.
- The examination and test results are recorded in confidential Report No. **GB/BAS/ExTR08.0149/00**
- 9 Compliance with the Essential Health and Safety Requirements has been assured by compliance with:  
**IEC60079-0: 2007 EN60079-1: 2007 EN 61241-1: 2006**
- except in respect of those requirements listed at item 18 of the Schedule.
- 10 If the sign "X" is placed after the certificate number, it indicates that the equipment or protective system is subject to special conditions for safe use specified in the schedule to this certificate.
- 11 This EC - TYPE EXAMINATION CERTIFICATE relates only to the design and construction of the specified equipment or protective system. Further requirements of the Directive apply to the manufacturing process and supply of this equipment or protective system. These are not covered by this certificate.
- 12 The marking of the equipment or protective system shall include the following :
- Ⓔ II GD Ex d IIC Gb T6 (Ta -40°C to +65°C) Ex tb IIC T85°C Db IP66**
- This certificate may only be reproduced in its entirety, without any change, schedule included.

Baseefa Customer Reference No. **5989**

Project File No. **08/0201**

This certificate is granted subject to the general terms and conditions of Baseefa. It does not necessarily indicate that the equipment may be used in particular industries or circumstances.

**Baseefa**  
Rockhead Business Park, Staden Lane,  
Buxton, Derbyshire SK17 9RZ  
Telephone +44 (0) 1298 766600 Fax +44 (0) 1298 766601  
e-mail [info@baseefa.com](mailto:info@baseefa.com) web site [www.baseefa.com](http://www.baseefa.com)  
Baseefa is a trading name of Baseefa Ltd  
Registered in England No. 4305578. Registered address as above.

*DBrewley*  
*FP DISREARLES*  
**R S SINCLAIR**  
**DIRECTOR**  
On behalf of  
Baseefa

ATEX for Sensor

Certificate Number  
Baseefa08ATEX0263X



Issued 19 January 2009  
Page 1 of 3

- 1 **EC - TYPE EXAMINATION CERTIFICATE**
- 2 **Equipment or Protective System Intended for use in Potentially Explosive Atmospheres**  
Directive 94/9/EC
- 3 EC - Type Examination Certificate Number: **Baseefa08ATEX0263X**
- 4 Equipment or Protective System: **Sensepoint Toxic Gas Detector Head**
- 5 Manufacturer: **Honeywell Analytics limited**
- 6 Address: **4 Stinsford Road, Nuffield Estate, Poole, Dorset, BH17 0RZ**
- 7 This equipment or protective system and any acceptable variation thereto is specified in the schedule to this certificate and the documents therein referred to.
- 8 Baseefa, Notified Body number 1180, in accordance with Article 9 of the Council Directive 94/9/EC of 23 March 1994, certifies that this equipment or protective system has been found to comply with the Essential Health and Safety Requirements relating to the design and construction of equipment and protective systems intended for use in potentially explosive atmospheres given in Annex II to the Directive.  
The examination and test results are recorded in confidential Report No. **GB/BAS/ExTR08.0141/00 & GB/BAS/ExTR08.0142/00**
- 9 Compliance with the Essential Health and Safety Requirements has been assured by compliance with:  
**IEC 60079-0: 2007 EN 60079-0: 2006 EN 60079-1: 2007 EN 60079-11: 2007 EN 61241-1: 2004**  
except in respect of those requirements listed at item 18 of the Schedule.
- 10 If the sign "X" is placed after the certificate number, it indicates that the equipment or protective system is subject to special conditions for safe use specified in the schedule to this certificate.
- 11 This EC - TYPE EXAMINATION CERTIFICATE relates only to the design and construction of the specified equipment or protective system. Further requirements of the Directive apply to the manufacturing process and supply of this equipment or protective system. These are not covered by this certificate.
- 12 The marking of the equipment or protective system shall include the following :  
**Ⓔ II 2GD Ex d ia IIC T4 Gb Ex tb IIIC A21 IP67 T135°C Db (T<sub>amb</sub> -40°C to + 65°C)**  
This certificate may only be reproduced in its entirety, without any change, schedule included.

Baseefa Customer Reference No. 0981

Project File No. 08/0218



This certificate is granted subject to the general terms and conditions of Baseefa. It does not necessarily indicate that the equipment may be used in particular industries or circumstances.

**Baseefa**  
Rockhead Business Park, Staden Lane,  
Buxton, Derbyshire SK17 9RZ  
Telephone +44 (0) 1298 766600 Fax +44 (0) 1298 766601  
e-mail [info@baseefa.com](mailto:info@baseefa.com) web site [www.baseefa.com](http://www.baseefa.com)  
Baseefa is a trading name of Baseefa Ltd  
Registered in England No. 4305578. Registered address as above.

  
PP D3REARLES  
**R S SINCLAIR**  
DIRECTOR  
On behalf of  
Baseefa



### 18.4 International IEC

IEC Ex for Transmitter

		<h1>IECEX Certificate of Conformity</h1>	
<b>INTERNATIONAL ELECTROTECHNICAL COMMISSION</b> <b>IEC Certification Scheme for Explosive Atmospheres</b> <small>for rules and details of the IECEx Scheme visit <a href="http://www.iecex.com">www.iecex.com</a></small>			
Certificate No.:	IECEX BAS 08.0072	Issue No.:	1
Status:	Current	<b>Certificate history:</b> Issue No. 1 (2009-12-8) Issue No. 0 (2008-11-10)	
Date of Issue:	2009-12-08	Page 1 of 4	
Applicant:	<b>Honeywell Analytics</b> 405 Barclay Boulevard Lincolnshire Illinois 60069 United States of America		
Electrical Apparatus:	<b>A Type XCD Transmitter</b>		
Optional accessory:			
Type of Protection:	<b>Flameproof</b>		
Marking:	<b>Ex d IIC Gb T6 (Ta -40°C to +65°C)</b> <b>Ex tb IIIC T85°C Db IP66</b>		
Approved for issue on behalf of the IECEx Certification Body:	R S Sinclair		
Position:	Managing Director		
Signature: (for printed version)			
Date:	<u>8-12-09</u>		
<p>1. This certificate and schedule may only be reproduced in full. 2. This certificate is not transferable and remains the property of the issuing body. 3. The Status and authenticity of this certificate may be verified by visiting the <a href="http://www.iecex.com">Official IECEx Website</a>.</p>			
Certificate issued by:	<b>Baseefa</b> Rockhead Business Park Staden Lane Buxton Derbyshire SK17 9RZ United Kingdom		

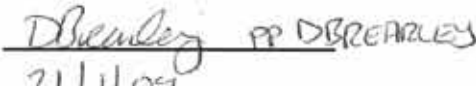
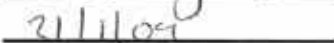

IEC Ex for Sensor

		<h1 style="margin: 0;">IECEX Certificate of Conformity</h1>	
<p><b>INTERNATIONAL ELECTROTECHNICAL COMMISSION</b>  <b>IEC Certification Scheme for Explosive Atmospheres</b>  <small>for rules and details of the IECEx Scheme visit <a href="http://www.iecex.com">www.iecex.com</a></small></p>			
Certificate No.:	IECEX BAS 08.0070X	Issue No.:	0
Status:	Current		
Date of Issue:	2009-01-20	Page 1 of 3	
Applicant:	<b>Honeywell Analytics Limited</b> Hatchpond House 4 Stinsford Road Nuffield Estate Poole Dorset BH17 0RZ United Kingdom		
Electrical Apparatus:	<b>Sensepoint Toxic Gas Detector Head</b>		
Optional accessory:			
Type of Protection:	<b>Flameproof, intrinsic safety and Dust</b>		
Marking:	<b>Ex d ia IIC Gb T4 (Tamb -40oC to + 65oC)</b> <b>Ex tb IIC A21 IP67 T135oC Db (Tamb -40oC to + 65oC)</b>		
Approved for issue on behalf of the IECEx Certification Body:	R S Sinclair		
Position:	Managing Director		
Signature: (for printed version)			
Date:			
<p>1. This certificate and schedule may only be reproduced in full.                  2. This certificate is not transferable and remains the property of the issuing body.                  3. The Status and authenticity of this certificate may be verified by visiting the <a href="http://www.iecex.com">Official IECEx Website</a>.</p>			
Certificate issued by:	<p><b>Baseefa</b>                  Rockhead Business Park                  Staden Lane                  Buxton                  Derbyshire                  SK17 9RZ                  United Kingdom</p>		

### 18.5 ATEX Name Plate

**3001EA041** REV 1

THIS DOCUMENT HAS BEEN GENERATED USING  
ADOBE ILLUSTRATOR AND MUST ONLY BE UPDATED BY A.I.

**Honeywell Sensepoint XCD**  
 Honeywell Analytical Inc., Lincolnshire, IL, USA 60466  
 Part 2 Approval ATEX Marking for use and print as per  
 MAFE 08123, Revision 1, Temp. Code 11, 230000 DC  
 PPA

CE   
 IECEx BAS 08.0072 / 1

WARNING: CONTACT WITH SURFACE INDICATED OR  
 IDENTIFIED BY THIS MARKING MAY BE DANGEROUS. IT  
 IS SUBJECT TO PATENT PROTECTION.

**Baseefa**  
 Certification  
 Schedule  
 Drawing

**IECEx BAS 08.0072 / 1**  
**baseefa 08 ATEX 0 2 2 2 / 1**

**NOTES**

1. This is an ATEX schedule drawing and can only be changed after approval is given by the certifying body
2. Product name format:  
 Honeywell Sensepoint XCD XXX  
 XXX — Blank - Sensepoint XCD for use with Sensepoint XCD socket and sensor.  
 E — RTD - Sensepoint XCD RTD for use with mA input sensors such as Sensepoint Toxic.  
 RFD - Sensepoint XCD RFD for use with mV input sensors such as Sensepoint Flammable
3. Serial no. format  
 S/N: SJJPPYYWNNN  
 S — Sequence number  
 J — Year of MFG  
 P — Part Code  
 Y — Issue State  
 W — Week of MFG  
 N — SUPPLIER CODE
4. Etching Depth : 0.1 mm

**THIS ITEM FORMS PART OF A CERTIFIED PRODUCT  
NO MODIFICATION PERMITTED WITHOUT  
REFERENCE TO CERTIFICATION DEPARTMENT**

SCALE	DATE	BY	REV.	DESCRIPTION
NONE		BEN-RJR	18	MAY 08

MATERIAL		MATERIAL		MATERIAL		MATERIAL		MATERIAL	
NO.	DESCRIPTION	NO.	DESCRIPTION	NO.	DESCRIPTION	NO.	DESCRIPTION	NO.	DESCRIPTION
2	18N0406	1	06EF08	2	06EF08	3	06EF08	4	06EF08
	ADD CMT. CHANGED MARKING		ADD CMT. CHANGED MARKING		ADD CMT. CHANGED MARKING		ADD CMT. CHANGED MARKING		ADD CMT. CHANGED MARKING
	ADD NOTES		ADD NOTES		ADD NOTES		ADD NOTES		ADD NOTES
J.Y.JN	J.Y.JN	J.Y.JN	J.Y.JN	J.Y.JN	J.Y.JN	J.Y.JN	J.Y.JN	J.Y.JN	J.Y.JN

**Sensepoint XCD**  
**ATEX Name Plate**

**3001EA041** REV 1

## **19 Cross Interference**

Please refer Sensepoint Technical Handbook (PN: 2106M0502) for detail



Thank you for reading this data sheet.

For pricing or for further information, please contact us at our UK Office, using the details below.



**UK Office**

**Keison Products,**

**P.O. Box 2124, Chelmsford, Essex, CM1 3UP, England.**

**Tel: +44 (0)330 088 0560**

**Fax: +44 (0)1245 808399**

**Email: [sales@keison.co.uk](mailto:sales@keison.co.uk)**

Please note - Product designs and specifications are subject to change without notice. The user is responsible for determining the suitability of this product.