

If the sensor does not stabilise during the initialisation period (15 minutes), one of the fault (F) or warning (W) alarm messages shown in Section 8 is displayed.

Clearing/resetting latched alarms



WARNING
Alarms should not be reset until it is confirmed that gas is not present.

- Press **esc** at the **Gas Reading** display. The Main Menu is displayed.
- Select (highlight) **Display Menu** from the list press **ok**.
- When prompted enter the current password. Obtain the password from the system administrator. The Display Menu is shown.
- Select the **Reset Alarms, Faults** option.
- Press **ok**. The Reset Alarms, Faults menu is displayed.

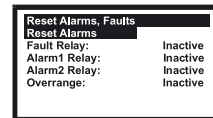

- Select **Reset Alarms** from the list.
- Press **ok**. The display returns to the Display Menu. Note: Alarms are not reset until the **esc** button is pressed to leave the Display Menu and return to the Main Menu.

In order to assist with the identification of problems, the Transmitter Unit displays a number of Fault (F) and Warning (W) messages. The Fault/Warning messages related to the sensor are listed below together with possible causes and remedies.

Message	Cause/Remedy
F: Sensor Failed	A Certified Sensor fault has developed. Check the connections between the Transmitter and Certified Sensor. If fault remains replace the complete Certified Sensor assembly.
F: No Cartridge	The Certified Sensor reports there is no cartridge fitted. Check that the cartridge is fitted correctly. If no cartridge present, fit required cartridge.
F: Wrong Cartridge	The wrong type of cartridge has been fitted in the Certified Sensor. Replace the cartridge with correct type for the target gas.
F: Cartridge Failed	The cartridge has failed. Replace the cartridge.
W: Temperature Error	The cartridge is being operated at temperatures outside its specified temperature range.
F: Temperature Error	Identify the cause of the temperature problem. Fit suitable accessories or relocate the Certified Sensor as appropriate.
W: End of Cell Life	The cartridge is reaching, or has reached, the end of its useful service life.
F: End of Cell Life	Warning - replace the cartridge within the next 3 months. Fault - replace the cartridge immediately.
FATAL FAULT	A fatal error has occurred. Note the displayed fault code and conditions, and contact the manufacturer for advice.
NO SENSOR	The transmitter can not detect the presence of the sensor.
Sensor Comms Fail	Sensor incorrectly connected or faulty. Check connections between Certified Sensor and transmitter unit. If connections correct but message remains, replace Certified Sensor

Procedures for calibration, component replacement, etc., are described in the Apex Technical Handbook.

A certification label is located on top of the APEX Transmitter Unit. The label contains all the relevant information regarding the product's identification and certification state.

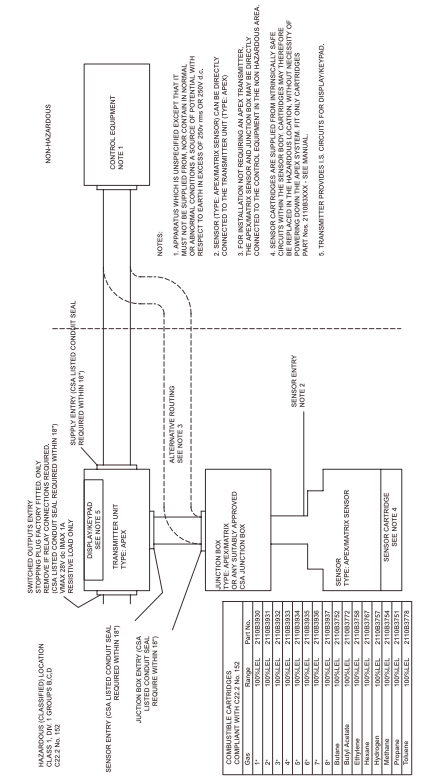
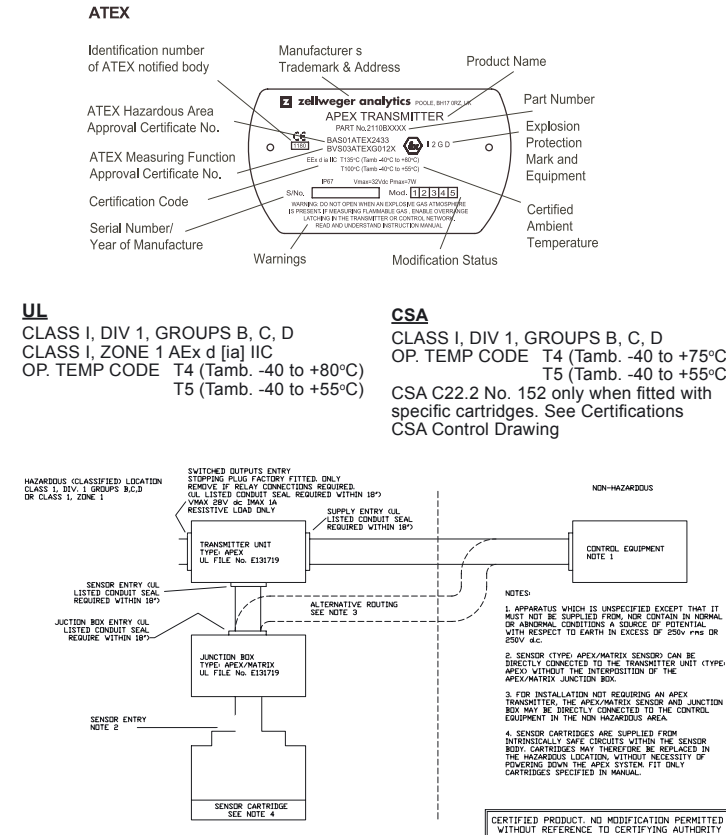

This Quick Start Guide (QSG) provides information to mechanically install the certified Apex Transmitter Unit, Certified Sensor and gas sensing cartridge, make electrical connections and power-up. It also gives basic instructions about how to operate the equipment.

The Apex Transmitter Unit is certified for use in potentially hazardous areas and is protected against water and dust ingress to IP66/67. It should be used in conjunction with the Certified Sensor and installed in accordance with local or national installation codes of practice.

The gas sensing system is designed to detect a number of gases. The Certified Sensor features an interchangeable cartridge that determines which gas is currently monitored. The output from the sensor provides a gas concentration reading that is displayed on the LCD screen on the front of the Apex Transmitter Unit and is also transmitted on its 4-20mA output and via an optional digital interface. A range of pre-calibrated sensor cartridges is available from Zellweger Analytics.

Local control of the unit is carried out via a system of hierarchical menus. Remote control of the unit is by the optional digital interface.

This guide assumes that the location and mounting of the gas detection system has previously been considered in accordance with the guidelines in the Apex Technical Handbook. In general, consideration should be made regarding potential gas leak sources, density of the gas to be detected, probability of mechanical impacts and interference from other equipment and apparatus.

For optimum performance the Apex Transmitter Unit should be installed in a location free from dust and direct sunlight. Sunshade and weather protection accessories are available for Certified Sensors in harsh environments.

The sensor may be optionally fitted remotely from the Apex Transmitter Unit. Details of this type of installation can be found in the Certified Sensor QSG.

Locations near antennae for high power radios, radar and satellites, together with environments subject to excessive mechanical vibrations are not recommended.

This guide is not intended to replace the Apex Technical Handbook that contains the full safety, installation, commissioning, maintenance and fault finding instructions.

Associated Documentation

- Apex Technical Handbook, MAN0604 Part No: 2110M8030
- Certified Sensor Quick Start Guide, MAN0598 Part No: 2110M8005
- Accessories Quick Start Guide, MAN0608 Part No: 2110M8008
- Refer to the relevant control system manual for external connections information (field wiring, etc.).

If information outside the scope of these instructions is required please contact Zellweger Analytics Ltd. The types of information notices used throughout this document are as follows:



WARNING
Indicates hazardous or unsafe practice which could result in severe injury or death to personnel.

Caution: Indicates hazardous or unsafe practice which could result in minor injury to personnel, or product or property damage.

Note: Provides useful/helpful/additional information.

This system is certified for and intended for use in potentially hazardous areas.

WARNINGS

- This gas detection equipment is certified for and intended for use in potentially hazardous areas. Install and use the equipment in accordance with current local and national regulations.
- Refer to the control drawings included in this document when installing the certified components.
- Operators should be fully aware of the action to be taken if the gas concentration exceeds the alarm level.
- Do not modify or alter the construction of the unit as essential safety requirements may be invalidated.
- This apparatus is not suitable for use in oxygen enriched atmospheres (>21%V/V). Oxygen deficient atmospheres (<10% V/V) may suppress some sensor outputs.
- This device is intended for use at atmospheric pressure only and should not be used in pressures exceeding 1.1 bar.
- INPUT VOLTAGE MUST NOT EXCEED THE STATED MAXIMUM (32V DC) AS ESSENTIAL SAFETY REQUIREMENTS MAY BE INVALIDATED AND THE UNIT MAY BE PERMANENTLY DAMAGED.**
- Alarms should not be reset until it is confirmed that gas is not present.
- Hazardous voltages may exist at alarm contacts. Ensure power is disconnected at source prior to servicing contacts.
- Gas events occurring while accessing the Transmitter Unit menus will not be reported locally.

CAUTIONS

- Refer to local or national regulations applicable to installation and use at the site.
- Installation should consider not only optimum siting for gas detection related to potential leak points, gas characteristics and ventilation but also placement where the potential for mechanical damage is minimized or avoided.
- When accessing the interior of the Transmitter Unit observe precautions for handling electrostatic discharge sensitive devices.
- Ensure that the Apex Transmitter Unit or Junction flamepath is not damaged during dismantling procedure. The flamepath is formed by the mating surfaces of the unit's top and bottom.
- During installation/maintenance only use the supplied parts. Replacement with alternatives will invalidate certification.
- Exposure to fluorinated hydrocarbons or silicones will poison the sensor beads on catalytic sensor cartridges. If a sensor is known to have been poisoned then it must be re-calibrated. If not sure then flow gas over the sensor and if the reading is incorrect re-calibrate within the cartridge's tolerance value (see Apex Technical Handbook for details).
- Exposures to gas above the recommended range may result in ambiguous readings and may require subsequent re-calibration of the sensor.
- When compliance with the ATEX EN50054 performance standard is required the warning and inhibit current shall not be configured to a value between than 3.1mA and 4.9mA.
- Do not use the unit where the temperature is lower than -40°C (-40°F) or higher than +65°C (149°F).
- Review cartridge data sheets for operating temperatures and humidities, which are determined on a cartridge by cartridge basis.
- The Transmitter Unit relays are for controlling external devices, such as lights or horns. Consult Zellweger Analytics for low current PLC applications.
- Dispose of the following components in accordance with local disposal regulations.
Materials used: Main Body: Stainless Steel User Interface: Zinc Alloy

3. INSTALLATION

This procedure describes how to install an Apex Transmitter Unit, fit a Certified Sensor to it and install a gas sensing cartridge. The procedure can be carried out by a single technician. The following points should be noted before installation is carried out.

- Read all the instructions before starting any of the installation procedures.
- Identify a suitable location with a flat surface where the Transmitter Unit can be mounted.
- Identify external cable requirements and the necessary cable entries to be used on the Transmitter Unit. Two entries are provided.
- The Certified Sensor must always point downwards to avoid collection of fluids and other materials on the face.
- When fitting components also refer to the Control Drawings (see Section 7).

The Apex Transmitter Unit complies with the EMC requirements of EN50270. In order to maintain compliance with this standard it is essential that the unit is installed correctly as detailed below. It is the responsibility of the installation design authority to ensure that the electrical installation meets appropriate standards.

1. The unit case should not be electrically connected to electrically noisy (dirty) metalwork or conductors. The case should be connected to a low noise (clean) earth line.
2. The entire length of the field cabling connected to each unit should be fully screened with the screen or conduit connected to a low noise earth.
3. The low noise earth line should only be connected to safety earth at a single point. Star earthing arrangements minimise earth current crosstalk. Field cabling shields should not be connected such that earth loops are produced.
4. The earth bonding arrangement must ensure that the maximum peak voltage between the unit case earth and any field cable conductor is less than 350V. Voltages in excess of this can cause permanent damage to the unit's RFI protection filters.
5. The use of a single, screening cable for each gas detector ensures maximum screening and minimum crosstalk. Cabling arrangements which use a single cable for connecting field devices compromise screening, increase the potential for crosstalk and prevent implementation of true star earthing.
6. Any electrical interference induced onto the 4-20mA loop conductors by the installation must be kept below the levels necessary to comply with the general requirements of EN50270. In practice, this means that peak noise currents induced on the current loop should be no greater than $\pm 0.25\text{mA}$.
7. The 0V rail of the control card/system is often directly connected to one side of the 4-20mA current sensing resistor. Electrical noise on such a rail is therefore directly connected to the 4-20mA input. In order to avoid additional noise being induced on the 0V rail, it should not be common with the safety earth/ground which frequently carries a high level of electrical noise.
8. The 24V supply should be free from large transients and fluctuations.

3

4. WIRING

The following information details the wiring for the Apex Transmitter Unit.



WARNING

Hazardous voltages may exist at alarm contacts. Ensure power is disconnected at source prior to servicing contacts.

1. Isolate all associated power supplies and ensure that they remain OFF when wiring the Transmitter Unit.
2. Connect the Apex Transmitter Unit, Certified Sensor and external wiring as shown in the following diagram and table.

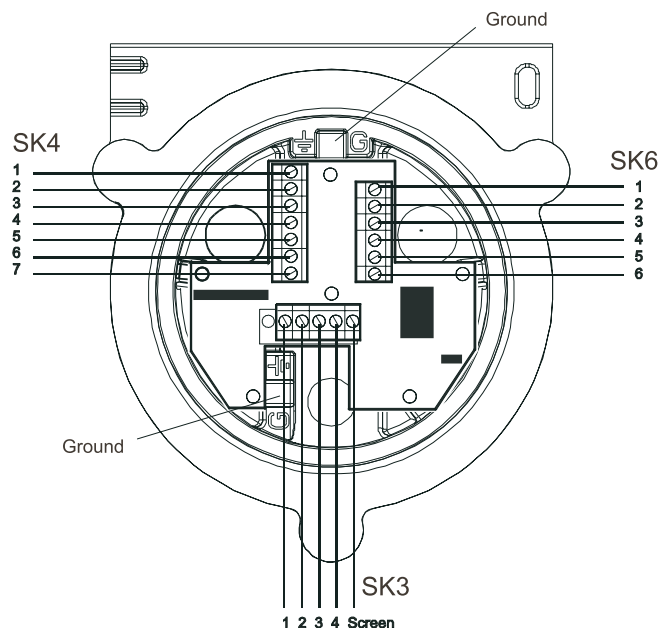

7

INSTALLATION

The following diagram identifies the main features and dimensions of the components.

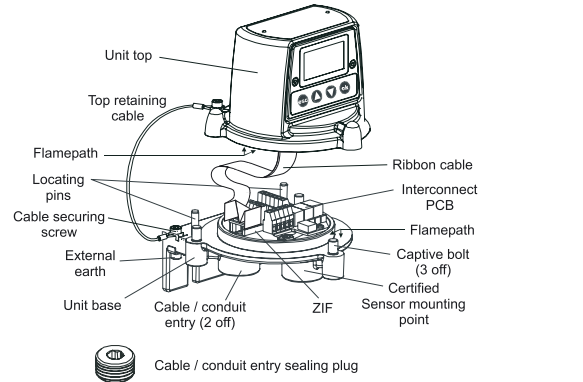

Width: 140mm Height: 150mm Depth: 152mm
Height with Certified Sensor fitted: 270mm (282mm with O₂ sensor)

Caution 1: Observe precautions for handling electrostatic discharge sensitive devices.

Caution 2: Ensure that the Transmitter Unit flamepath is not damaged during this procedure. The flamepath is formed by the mating surfaces of the Transmitter Unit top and base (see diagram).

1. Isolate all associated power supplies and ensure that they remain OFF during the installation procedure. Ensure a gas free atmosphere.
2. Attach the Transmitter Unit to the supporting structure.
Drill two mounting holes (68mm apart) and use the unit's mounting slots in the base with either two M10 bolts or a single 10mm U-bolt.
3. Detach the top of the Transmitter Unit.
Unscrew the three captive M8 bolts in the base. Support the top and let the metal retaining cable, attaching the top to the base, hold the top. Take care not to damage or strain the ribbon cable between the top and the base.
4. Fit and connect the field wiring.
See Section 4 for wiring details. Use either:
Conduit - using one or both of the 3/4" NPT conduit entries. Ensure that a conduit sealing fitting is placed within 460mm of the enclosure on all conduit runs.

4

WIRING

Ensure the recommended length of wire is allocated to each terminal. Surplus wire length can be located about the base of the Interconnect PCB. Ensure that the wires and ribbon cable are not trapped by the top when fitted.

Terminal Recommended Number	Function	Colour	Wire Length	
SK3 (Sensor)	1	CAN_L	White	40mm
	2	CAN_H	Blue/Green	40mm
	3	+V	Red	40mm
	4	0V	Black	40mm
	5	Screen	-	40mm
SK4 (Comms and Power)	1	NET1	-	60mm
	2	NET2	-	60mm
	3	Screen	-	50mm
	4	4 - 20mA -	-	50mm
	5	4 - 20mA +	-	50mm
	6	0V	-	50mm
	7	+24Vdc (18-32Vdc)	-	50mm
SK6 (Relays)	1	Fault	-	50mm
	2	Fault common	-	50mm
	3	Alarm 1	-	50mm
	4	Alarm 1 common	-	50mm
	5	Alarm 2	-	50mm
	6	Alarm 2 common	-	50mm

G - Earth Green/Yellow

Note: Total power supply loop resistance should be less than 30 ohms (with ECC cartridge fitted) or 16 ohms (with catalytic cartridge fitted). Typical power consumption with relays active is 3.6W (ECC cartridge) or 5.6W (catalytic).

8

INSTALLATION

Cable - using any suitable flameproof cable entry device certified as Equipment to Directive 94/9/EC (ATEX).

Note: All unused cable/conduit entries must be sealed with a suitable certified sealing plug (one plug is supplied).

5. Fit the Certified Sensor to the Transmitter Unit.

Feed the sensor cable through the sensor mounting point at the front of the Transmitter Unit base. Screw the sensor into the mounting point until it is fully home.

To mount the sensor remotely from the Transmitter Unit see the Certified Sensor Quick Start Guide, MAN0598 (Part No: 2110M8005).

6. Connect the sensor wiring.

See Section 4 for wiring details.

7. Configure the Transmitter Unit if required.

Set the links on the interconnect board for the required relay contact settings and for the 4-20mA topology (see Section 5).

8. Refit the top to the base.

Caution 1: Ensure that there is no moisture inside the unit before fitting the top.

Caution 2: Use only the captive bolts supplied, replacement with alternative bolts will invalidate certification.

Follow the reverse of the removal procedure supporting the top. The top should be positioned using the locating pins on the Apex Transmitter Unit base and then lowered onto the base. Ensure that the lid retaining cable and wiring is not trapped and the O-ring in the top is correctly located.

Ensure that the ribbon cable is not twisted and is correctly positioned. Check that there is no discernible gap between the top and the base. Tighten the three captive M8 bolts to 5Nm (3.68 foot-pounds).

9. Remove the cap from the Certified Sensor body.

Rotate the cap or accessory 1/4 turn in an anticlockwise direction to release the bayonet fitting.

10. Fit the gas sensing cartridge into the sensor body.

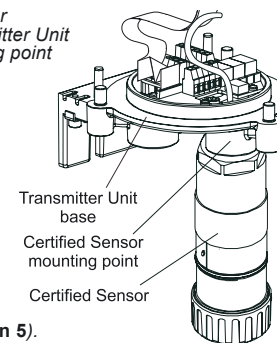

5

5. CONFIGURATION

This section specifies the unit configuration options for the internal relays and for the 4-20mA loop.

Relays

Default relay configurations are:
Alarm 1 and **Alarm 2** - normally open, normally de-energised, i.e. closed contact on alarm, opens on power failure.

Fault - normally open, normally energised, i.e. closed when in normal operation, opens on fault or power failure.

Links **J1**, **J2** and **J3** set the contact operation for the **Fault**, **Alarm 1** and **Alarm 2** relays respectively.

J1 - for Fault relay

- Normally open (default)
- Normally closed

J2 and J3 - for Alarm 1 and 2 relays

- Normally open (default)
- Normally closed

Notes: Relay contacts are rated at 100mA (min), 2A (max), 30Vdc non-inductive*.

HIGHER VOLTAGES MUST NOT BE USED
* UL/CSA specification: 28Vdc, 1A

4-20mA Loop

The table identifies the link and terminal connections for 4-20mA loop options.

Link	SK4 Terminal	4 - 20mA loop topology		
		Isolated	Source	Sink
J4	-	<input type="checkbox"/>	<input type="checkbox"/>	<input type="checkbox"/>
J5	-	<input type="checkbox"/>	<input type="checkbox"/>	<input type="checkbox"/>
-	4	4 - 20mA -	4 - 20mA -	not used
-	5	4 - 20mA +	not used	4 - 20mA +

9

INSTALLATION



WARNING

Sensor Cartridges may contain corrosive solutions. Dispose of according to local and national regulations.

Each cartridge is provided with a certificate of calibration (printed on the reverse of its instruction sheet, Part No: 2110M8015), supplied with the cartridge that guarantees that the cartridge is calibrated and ready for use.

Before installing a cartridge check that the number on the cartridge label matches the gas type and range for the function required.

Caution: Only cartridges with the following part numbers can be fitted to the sensor: 2110B30x0, 31x0, 32x0, 33x0, 34x0 series 2110B3700 - 2110B3999 range

Note: Sensor certified to CSA C22.2 No. 152 only when fitted with specific cartridges. See Certifications - CSA Control Drawing

Carefully plug the cartridge into the Certified Sensor body ensuring that the cartridge tab lines up with the recess in the sensor body and push the cartridge, without twisting, until it is fully home.

If the cartridge will not push fully home, re-check that the locating tab is correctly aligned with the recess in the sensor body. Position the tab so it is resting on the tab recess wall to the right or left of the tab recess and then turn the cartridge until the tab drops into the recess.

Caution: Do not force the cartridge as this may cause damage to the pins of the connecting plugs. Twisting and pushing can bend the pins and make the cartridge inoperative.

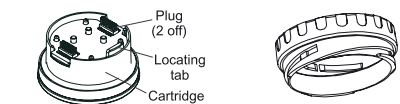

Note: If fitting an Oxygen cartridge ensure that the Oxygen Transducer Adaptor supplied with the Oxygen cartridge is fitted to the Certified Sensor body. The adaptor is fitted to the sensor body via a bayonet fitting.

11. Refit the cap to the Certified Sensor.

Reverse the removal procedure.

6

6. OPERATION

Power-up the Apex Transmitter Unit. With a correctly installed sensor fitted, or remote sensor connected, the following information is shown sequentially on the LCD screen:

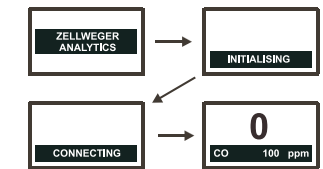

The Transmitter Unit initially waits for the sensor to stabilise, during which period the 4-20mA output is inhibited (2mA). Wait for 15 minutes to ensure stabilisation has occurred before continuing.

After the sensor stabilises, the display shows the current Gas Reading together with the gas identity and the units of measurement. This information is also transmitted on the 4-20mA output and optionally on the digital network if a communications board is fitted in the Transmitter Unit.

The Apex unit is controlled for set-up, calibration, etc., via a hierarchical system of menus that are displayed on the screen and accessed and navigated by use of the four buttons below the display.



The system Main Menu is accessed by pressing the **ESC** button at the Gas Reading display.

Caution: Gas events occurring whilst in menus are not reported locally.

Use the **▲** (up) and **▼** (down) buttons to move through the menu lists and to select (highlight) a required menu option. Also use to increment/decrement displayed values.

The **OK** (ok) button activates/acknowledges the chosen/displayed item. The **ESC** (esc) button is used to exit the currently displayed screen and return to the previous screen or option.

When prompted at any stage enter the four digit password using the four buttons in sequence. The password is entered by pressing the **ok**, **up**, **down** and **down** buttons in sequence. Passwords are shown using asterisks (*) on the screen.

Note: For detailed information about menu system options and passwords see the Apex Technical Handbook.

The first level of options for each of the menus is as follows:

10



Thank you for reading this data sheet.

For pricing or for further information, please contact us at our UK Office, using the details below.



UK Office

Keison Products,

P.O. Box 2124, Chelmsford, Essex, CM1 3UP, England.

Tel: +44 (0)330 088 0560

Fax: +44 (0)1245 808399

Email: sales@keison.co.uk

Please note - Product designs and specifications are subject to change without notice. The user is responsible for determining the suitability of this product.