

**Model 9500
Dissolved Oxygen Meter
Operating Manual**

SAFETY

Please read this information carefully prior to installing or using this equipment.

1. The unit described in this manual is designed to be operated only by trained personnel. Any adjustments, maintenance and repair must be carried out as defined in this manual, by a person qualified to be aware of the hazards involved.
2. It is essential that both operating and service personnel employ a safe system of work, in addition to the detailed instructions specified in this manual.
3. References should always be made to the Health & Safety data supplied with any chemicals used. Generally accepted laboratory procedures for safe handling of chemicals should be employed.
4. If it is suspected that safety protection has been impaired in any way, the unit must be made inoperative and secured against any intended operation. The fault condition should immediately be reported to the appropriate servicing authority.

**Model 9500
Dissolved Oxygen Meter
Operating Manual**

Contents

Section 1	Introduction	
	Instrument Description	1.1
	Instrument Specification	1.2
Section 2	Installation	
	Unpacking	2.1
	Installation	2.2
	Displays	2.3
	Keypad	2.4
	Inputs/Outputs	2.5
Section 3	Operation	
	Good Practice Guidelines	3.1
	Set Up Parameters	3.2
	%DO ₂ Mode	3.3
	B.O.D.	3.4
	Status Page	3.5
	Results Storage & Display	3.6
	GLP Functions	3.7
Section 4	Maintenance	
	General	4.1
	Probe Care & Maintenance	4.2
Section 5	Optional Accessories	
	Optional Accessories	5.1
	Spares	5.2
Section 6	Interfacing	
	Analogue	6.1
	RS232	6.2
	Keypad Emulation	6.3
	Printing	6.4
	Alarm Outputs	6.5
Section 7	Troubleshooting	
	Troubleshooting	7.1

Health & Safety

EC Declaration of Conformity

**Model 9500
Dissolved Oxygen Meter
Operating Manual**

Section 1

Introduction

1.1 Instrument Description

The 9500 is a fully specified DO₂/Temperature meter that includes full support for the B.O.D. 5-day test protocol. Up to 20 B.O.D. tests, each with up to 10 samples, can be stored. Powerful data logging capabilities are included, with the ability to store up to 250 DO₂ readings either manually, at timed intervals or alarm events.

1.2 Specification

DO₂	
Ranges	0 to 199% / 0 to 25.0% / 0 to 19.99mg/l
Resolution	1% / 0.1% / 0.01mg/l
Accuracy	±2% within 10°C of calibration temperature
Pressure correction	Manual
Salinity correction	Manual
Temperature	
Range	-10 to +60°C (14 to 140°F)
Resolution	0.1°C (1°F)
Accuracy	±0.5°C (±1°F)
ATC Range	0 to 60°C (32 to 140°F)
Manual Temp. Comp. Range	0 to 60°C (32 to 140°F)
Calibration	Automatic
Outputs	Analogue RS232 serial & IrDA printer interface Alarm
Clock	24 hours, hrs/min/sec or day of month/month/year leap year corrected (European and American formats)
GLP	Calibration reminder interval (1 to 999 hours) Alarm outputs (open collector and audible) Security code protected user data
Display	Back lit 1/8 VGA monochrome LCD
Language option	English, French, German, Italian, Spanish, Portuguese
Power	9V power supply
Size	210x250x55mm
Weight	850g

Section 2

Installation

2.1 Unpacking

Remove the Model 9500 from the packaging and ensure the following items are included:

1. Model 9500 Dissolved Oxygen Meter
2. Dissolved Oxygen probe with ATC (522 008)
3. 3 membranes & KCl solution (522 019)
4. Zero salts (983 030)
5. Adaptor bush
6. Electrode holder
7. Power Supply (as specified at time of ordering the product)
8. Condensed operating instructions (950 051)
9. Operating Manual (950 050)

The electrode stand requires minimal assembly (refer to the diagram below)
Any shortages or damage should be reported immediately to the manufacturer or your local distributor.

2.2 Installation

The Model 9500 is supplied ready to use. Connect the dissolved oxygen probe to the rear panel DIN socket.

The electrode stand requires minimal assembly (refer to the diagram below).

Fig. 2.2.1 Electrode Holder Assembly

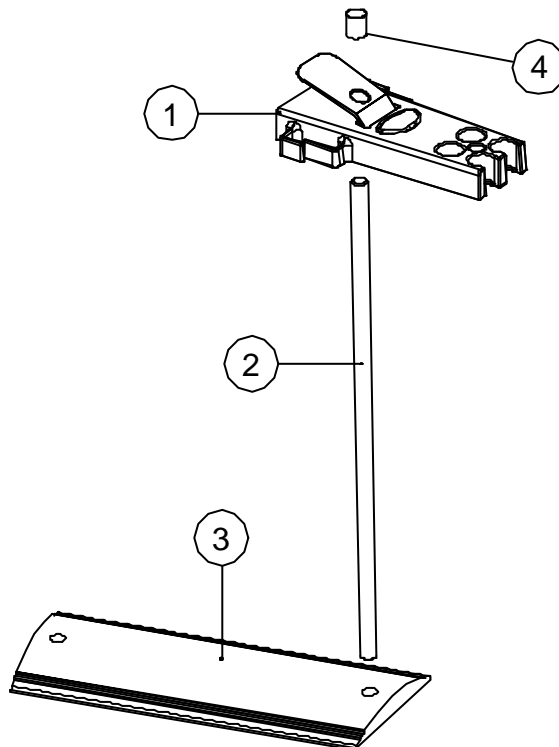

Preparation for use

The probe is delivered with the membrane module detached. Prior to use the membrane module must be fitted to the probe body.

A protective cap is also supplied. This should be fitted to the probe when not in use. The sponge contained within the cap should be wetted with deionised water prior to fitting. This covers the membrane and keeps it wet, thus preventing the electrolyte filling solution from drying out.

1. Remove the protective cap from the probe.
2. Take a membrane module and hold in the vertical position. Fill with the electrolyte solution (5% KCl) supplied with the instrument.
3. Whilst still holding the module upright, screw the probe slowly down onto the thread, allowing the excess electrolyte to escape through the screw thread. Ensure no air bubbles are present and that the membrane is not creased.
4. Connect the probe to the 9500 and turn on the instrument.
5. The complete probe and meter should be allowed to polarise for 30 minutes prior to calibration.

2.3 Displays

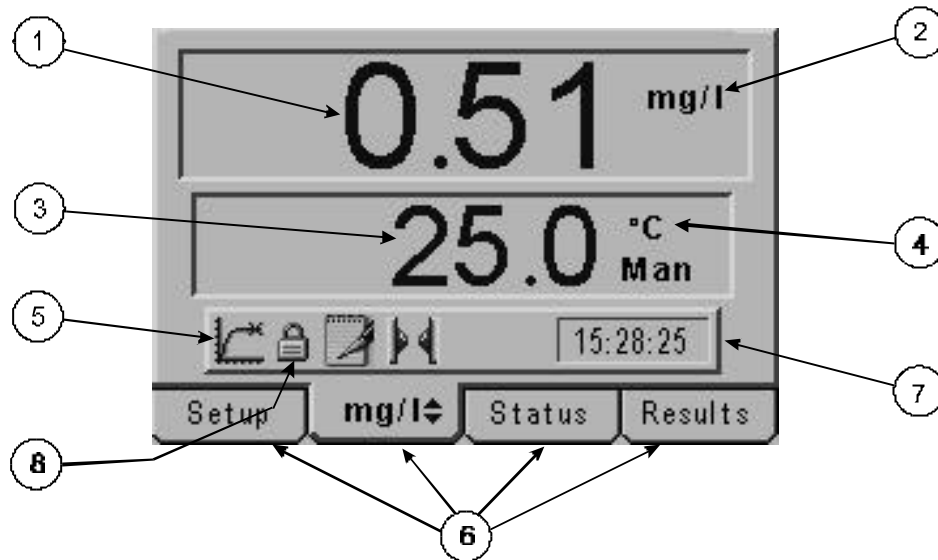

1. Primary display – 4½ digit. Provides direct readout in %DO₂ , mg/l or BOD of samples and standards.
2. Mode annunciators – shows selected measurement mode; %DO₂ , mg/l or BOD.
3. Secondary display – 3½ digit display. Provides direct readout of automatic or manual temperature. Also displays B.O.D. set up information when working in B.O.D. mode.
4. Mode annunciators – indicates temperature in °C or °F and whether the measurements are manually temperature compensated (MAN symbol).
5. Endpoint symbol – this symbol is displayed when an endpoint has been detected.
6. Mode tags – Each mode tag is highlighted when selected; SETUP, MODE (DO₂, mg/l or B.O.D.), STATUS or RESULTS. If a double headed arrow symbol is present this indicates that the mode can be changed to an alternative option.
7. Real time clock - will display either date or time.
8. The following symbols will appear along the display in %DO₂ and mg/l modes:

Padlock - Set up parameters security locked

Notepad symbol - data logging to internal memory

IrDA status

Alarm indication - an Up arrow refers to Hi alarm / a Down arrow refers to Low alarm.

2.4 Keypad

2.4.1 Keypad layout

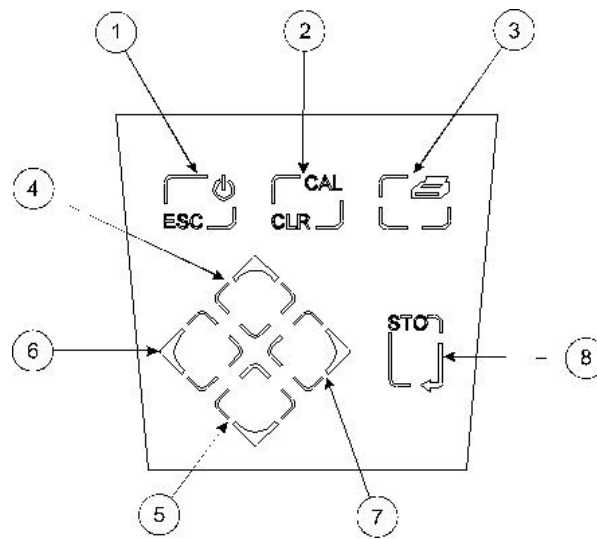

- | | |
|--------------|---|
| 1. ESC | used to switch the instrument on and to place into standby mode (only if power supply lead remains connected to the instrument). Also used to escape/exit a mode. |
| 2. CAL / CLR | used to select and perform a calibration sequence. This key is also used to clear readings from Memory. |
| 3. Print key | used to initiate a print. |
| 4. Up Arrow | used for adjustment during set up, to scroll results and to toggle between modes. |
| Down Arrow | used for adjustment during set up, to scroll results and to toggle between modes. |
| Left Arrow | used for adjustment during set up and to move between mode tags. |
| Right Arrow | used for adjustment during set up and to move between mode tags. |
| STO | used to accept an entered value in set-up mode and to instigate a stored reading. This key can also be used as a CAL key during calibration. |

2.5 Inputs/Outputs

Fig 2.5.1 Rear panel layout

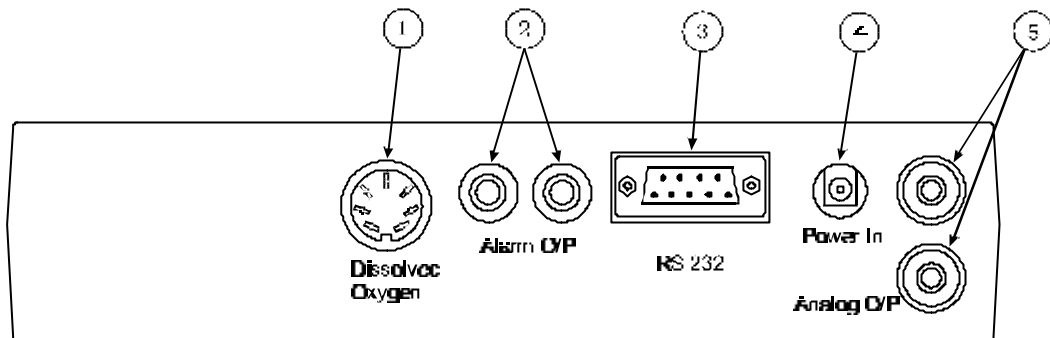

- | | |
|---------------------|---|
| 1. Dissolved Oxygen | 7 pin DIN socket for connection of DO ₂ probe. |
| 2. Alarm Output | 2 x 4mm sockets. Open collector alarm outputs.
Red for Hi / Black for Low. |
| 3. Printer Socket | 9 way socket for RS232 connection. |
| 4. Power In | AC 9V I/P socket. 2.1 x 5.5mm socket allowing the power supply to be connected to the instrument. |
| 5. Analog Out | 2x4mm sockets. Analogue output. |

Section 3

Operation

3.1 Good Practice Guidelines

1. Ensure the membrane is kept wet at all times. When not in use the probe should be stored with the tip in a beaker of deionised water. For longer periods (overnight) the protective sheath should be fitted, with the sponge insert soaked in distilled water. This will prevent the electrolyte fill solution from drying out due to loss of water through the porous membrane. For extended periods store dry.
2. The probe is fitted with a temperature compensating element. This is housed underneath the silver ring on the probe body. Always ensure the probe is immersed in solution to a depth suitable to cover this ring. Allow sufficient time for these to respond if measuring samples with varying temperatures or where sample temperature is significantly different to ambient temperature.
3. Ensure the sample is moving across the membrane at a speed greater than 15cm/min to avoid oxygen starvation at the membrane. If the flow rate is insufficient then the sample should be stirred (e.g. either by a gentle stirring motion with the probe or with a magnetic stirrer).
4. When using the probe in liquors, sludges or polymers a coating may be deposited on the membrane, causing low response or drifting. This can be reduced by rinsing the probe in deionised water after each test.
5. Ensure the probe is rinsed in deionised water after each test.
6. When measuring in mg/l (ppm) results are pressure dependent and determinations carried out at pressures other than 760mm/Hg will need to be compensated.
7. When measuring in mg/l (ppm) results obtained from saline samples will need to be adjusted for salinity.
8. Ensure the probe is polarised prior to use (refer Operation). It is essential to perform this procedure after replacement of the membrane or probe.
9. When replacing the membrane ensure no air bubbles are trapped in the electrolyte fill solution and that the membrane is not creased or damaged after fitting. If the probe response is sluggish, or the readout is unstable after membrane replacement, clean the anode and cathode (refer Section 4.2 Maintenance).

3.2 Set Up Parameters

The following section details the set-up modes available to the user on the main set up menu screen:



3.2.1 Instrument Setup

This option will allow the following parameters to be set:



- | | |
|--------------------|---|
| Exit | allows the user to exit this menu. |
| Language | enables the selection of the appropriate language – English, French, German, Italian, Spanish or Portuguese. Use the Up/Down keys to scroll through the language options. |
| LCD Brightness (%) | enter the value using the keypad. Press the STO key to accept the value. |

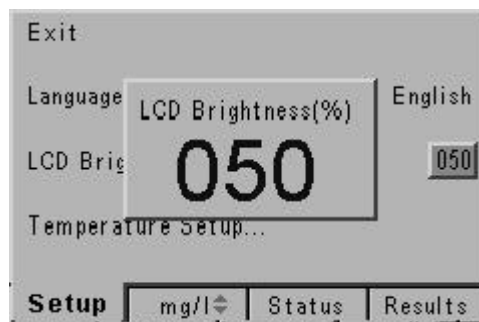

3.2.2 Temperature Setup...

Select the Temperature Setup sub menu by highlighting the option and pressing the STO key. The following menu will be shown:

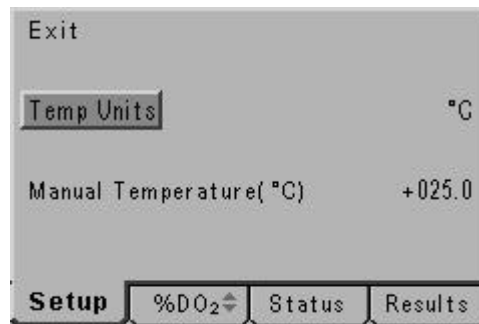

Temp units allows selection of the preferred unit of measurement (either °C or °F) using the Up/Down keys which toggle between the two units.

Manual temperature allows the manual temperature value to be set. Press the STO key to accept the value.

3.2.3 Calibration Set up ...

This option allows the following parameters to be set:

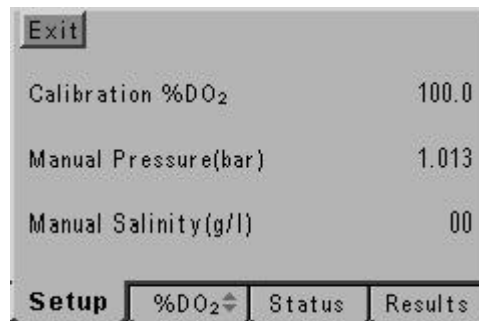

Exit enables the user to exit the Setup menu and return to the main set up screen.

Calibration %DO₂ allows the setting of %DO₂ value for calibration between the limits of 0.1 to 199.9 using the Up/Down arrow keys.

Manual Pressure (bar) allows the setting of the current barometric pressure between the limits of 0.1 to 6.0bar using the Up/Down keys.

Manual Salinity (g/l) allows the setting of salinity values between the limits of 0.0 to 75.0.

3.2.4 Alarms Setup...

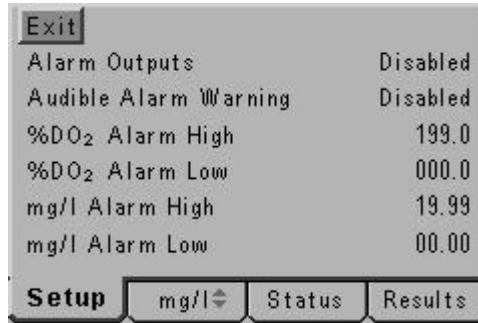

- Exit enables the user to exit the Setup menu and return to the main set up screen.
- Alarm Outputs can be enabled or disabled by using the Up/Down keys which toggle between the two settings.
- Audible Alarm Warning can be enabled or disabled by using the Up/Down keys which toggle between the two settings.
- %DO₂ Alarm High allows the user to set the high alarm limit up to 199.0
- %DO₂ Alarm Low allows the user to set the low alarm limit down to 000.0
- mg/l Alarm High allows the user to set the high alarm limit up to 19.99
- mg/l Alarm Low allows the user to set the low alarm limit down to 00.00

3.2.5 G.L.P Setup ...



- Exit enables the user to exit the Setup menu and return to the main set up screen.
- Cal Reminder can be enabled or disabled by using the Up/Down keys which toggle between the two settings.
- Cal Reminder Interval can be set within the limits of 001 to 999 hours by using the Up/Down keys. The Left/Right arrow keys allow forward and backward movement along the row of digits. Press the STO key to accept the value.
- Cal Reminder Audible Alarm can be enabled or disabled by using the Up/Down keys which toggle between the two settings.
- User ID up to a 4 digit code can be set using the Up/Down keys. The Left/Right arrow keys allow forward and backward movement along the row of digits. Press the STO key to accept the value

Batch ID up to a 3 digit code can be set by using the Up/Down keys. The Left/Right arrow keys allow forward and backward movement along the row of digits. Press the STO key to accept the value.

3.2.6. Security Setup ...

Select the Security Setup sub menu by highlighting the option and pressing the STO key. The following menu will be shown:

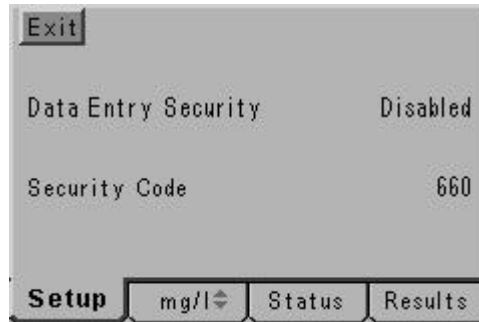

- Exit enables the user to exit the Set Up menu and return to the previous set up screen.
- Data Entry Security can be enabled or disabled by using the Up/Down keys which toggle between the two settings.
- Security Code up to a 3 digit code can be set by using the Up/Down keys. The Left/Right arrow keys allow forward and backward movement along the row of digits. Press the STO key to accept the value.

3.2.7 Data Logging Set up ...



- Exit enables the user to exit the Set Up menu and return to the main set up screen.
- Data Log Event can be enabled or disabled by using the Up/Down keys which toggle between the two settings.
- Data Log To allows the data to be sent to Memory or to the external Printer. Selection is made via the Up/Down keys which toggle between the two settings.

Data Log Interval	can be set between 00:00:01 and 23:59:59.
Memory Full	gives the user to select the Stop (cease storing results and not to overwrite existing stored information) or Overwrite (overwrite existing results) options when the memory is full. Selection is made via the Up/Down keys which toggle between the two settings.
Prompt Before Deleting	can be enabled or disabled by using the Up/Down keys which toggle between the two settings.
Clr Key	toggles between Deletes Results Before, Deletes All Results and Deletes Results Since. Selection is made via the Up/Down keys which toggle between the four settings.

3.2.8 Printer Setup ...

Select the Printer Setup sub menu by highlighting the option and pressing the STO key. The following menu will be shown:

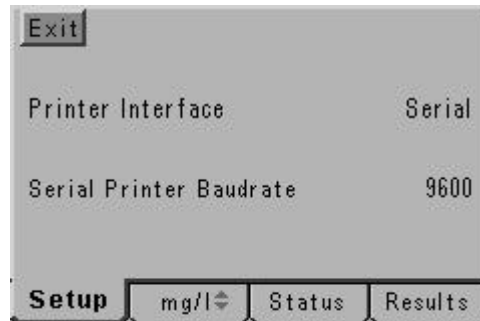

Exit	enables the user to exit the Setup menu and return to the main instrument display.
Printer Interface	toggles between Infrared and Serial. Selection of the preferred option can be made using the Up/Down keys which toggle between the two settings.
Serial Printer Baudrate	toggles between 9600 and 1200. Selection of the preferred option can be made using the Up/Down keys which toggle between the two settings. (Refer Section 6.2).

3.2.9 Endpoint Detection Set up ...

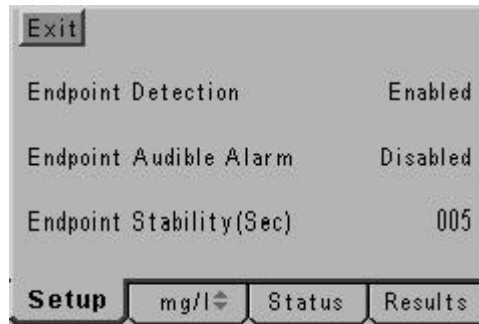

- Exit enables the user to exit the Set Up menu and return to the main instrument display.
- Endpoint detection can be enabled or disabled by using the Up/Down keys which toggle between the two settings.
- Endpoint Audible Alarm can be enabled or disabled by using the Up/Down keys which toggle between the two settings.
- Endpoint Stability (Sec) can be set within the limits of 001 to 999 seconds.

3.2.10 Clock Set up ...

Select the Clock Setup sub menu by highlighting the option and pressing the STO key. The following screens will be shown:

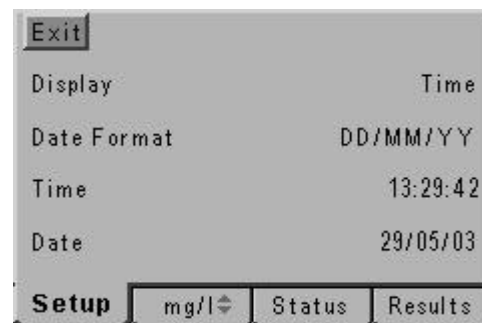

- Exit enables the user to exit the Setup menu and return to the main instrument display.
- Display toggles between Time and Date. Selection of the preferred option can be made using the Up/Down keys which toggle between the two settings.
- Date Format toggles between European (DD/MM/YY) and American (MM/DD/YY) formats. Selection of the preferred option can be made using the Up/Down keys which toggle between the two settings.
- Time allows time to be set (hrs/min/sec) using the Up/Down keys. The Left/Right arrow keys allow forward and backward movement along the row of digits. Press the STO key to accept the setting.
- Date allows date to be set (in previously selected format – European or American) using the Up/Down keys. The Left/Right arrow keys allow forward and backward movement along the row of digits. Press the STO key to accept the setting.

3.3 %DO₂ MODE

This gives a direct readout of the %DO₂ of the sample under test as either % oxygen saturation or % air saturation. If a cal value <25.0% is entered the resolution will automatically increase to 0.1%.

% Oxygen Saturation - this will give a reading of 20.9% in air where 20.9% is the amount of oxygen as a percentage of oxygen in air and will give a reading directly as a percentage of oxygen in the sample. All measurements in this range are given to a resolution of 0.1%.

% Air Saturation - this will directly assign a percentage dissolved oxygen to air saturated water and further readings are then given as a percentage of this air saturated water sample. All measurements in this range are given to a resolution of 1%.

DO₂ Calibration

If DO₂ measurements are to be performed in mg/l the current barometric pressure should be entered into the instrument via the Calibration Setup... menu.

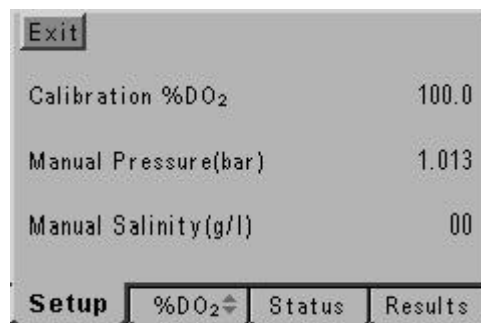

Calibration %DO₂ allows the setting of %DO₂ value for calibration between the limits of 0.1 to 199.9 using the Up/Down arrow keys.

Manual Pressure (bar) allows the setting of the current barometric pressure between the limits of 0.1 to 6.0bar using the Up/Down keys.

Manual Salinity (g/l) allows the setting of salinity values between the limits of 0.0 to 75.0.

Prepare a zero oxygen solution by mixing 2gms of sodium sulphite in 100mls of water. Allow to stand for a few minutes prior to use.

To perform a calibration select the DO₂ measurement mode. Immerse the probe in the prepared zero solution and stir gently for approximately two minutes. Press the CAL/CLR key. Once the reading has stabilised (if the endpoint detection is enabled the endpoint symbol will be displayed). The display will update to show:

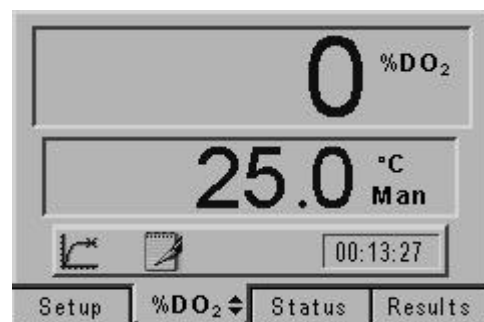

Remove the probe from the zero solution.

Fill a suitable container with a sample of clean water. Hold the probe so that the membrane is close to, but not touching the surface of the water (approx. 1 cm above).

Press the CAL/CLR key. Once the reading has stabilised (if the endpoint detection is enabled the endpoint symbol will be displayed). The display will update to show:

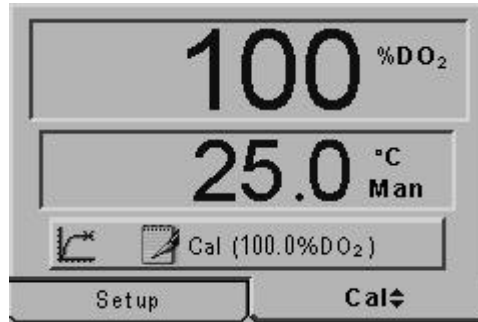

3.4 B.O.D (Biochemical Oxygen Demand)

B.O.D (Biochemical Oxygen Demand) measurements are important in water treatment plants, laboratories and industrial waste water facilities for water quality testing and pollution control.

The B.O.D test is a measure of the amount of oxygen that is consumed by bacteria as they decompose the organic components of waste. Dissolved oxygen measurements are made at the beginning and end of a five day incubation period for the standard five day B.O.D test.

The dissolved oxygen probe membrane is not affected by interfering ions, the pH of the sample, sludge, clays or inorganic matter. This is due to the electrolytic cell being separated from the sample by a selectively permeable membrane through which only gases can pass. The potential within the electrolytic cell is adjusted so that only the oxygen is reduced at the cathode, giving rise to a current flow proportional to the partial pressure of oxygen in the sample.

B.O.D. Measuring Screen

The main BOD screen serves 2 purposes:

1. to display the measuring screen and current sample number selected.
2. to display the BOD answer if a measurement has been taken.

Note: In this mode the padlock and IrDA icon are not displayed, even when enabled.



If there is a BOD answer, it is displayed on the measuring screen. To identify when the measuring screen is displaying a BOD answer, BOD is shown under the units of measure. Below the BOD caption is the incubation period in days providing the BOD conditions have been met.

Shown at the bottom of the results screen, 'Day (n) – Day (0)' relates to the time elapsed for day (n) and day (0) of the current sample reading, it does not relate to the blank readings.

To view a BOD answer straight away, after recording a day (n) reading. The user can choose no when prompted to increment sample number. To move to the next sample for the day (n) reading the user can change the sample number in the set-up menu.

Measuring Screen - Incubation Days

The Incubation period is only shown as 5 or 7 days, depending on the time elapsed between the two readings. There is a 4-hour window either side of 5 days (120 hours), whereby if the time elapsed is within this window; the number 5 is shown underneath BOD (the same applies for 7 days respectively). If the time elapsed is outside those boundaries, nothing is shown below BOD.

In any given batch, if the time period since the first reading stored is greater than 24 hours the flashing cursor will automatically move to the right highlighting the blank or sample square depending on the selection of sample type within the BOD set-up screen.

Results Screen

The result screen shows all results for the current selected batch. If there is no saved result or time elapsed data then —:— is displayed in the results place.

S(id)	Vt/Ve	S(0)	S(n)	BOD	DD:HH
1	5.00	5.86	5.86	2.80	3:0
2	5.00	13.75	7.46	34.25	3:0
3	5.00	6.56	5.86	6.30	3:0
4	5.00	10.32	12.79	-9.55	3:0
5	5.00	8.65	6.56	13.25	3:0
6	5.00	7.46	6.56	7.30	3:0
7	5.00	5.86	5.82	4.00	3:0
8	5.00	8.65	6.26	14.75	3:0
9	5.00	10.32	6.26	23.10	3:0
10	5.00	12.79	7.07	31.40	3:0

Setup BOD ⇅ **Results**

Batch & Sample ID stay the same unless the user increments the sample number when storing a result or edits the sample or batch ID within the BOD set-up menu.

The sample and solution volume can be changed for every sample, the divisible is shown on the results screen. The value shown in the set-up screen for the sample and solution volume is that of current reading, and doesn't relate to previous values used for previous readings. The exact values used for the sample and solution volume for each sample are shown on the BOD result printout.

Exit	
Sample Volume(Ve)ml	0050
Total Volume(Vt)ml	0250

Setup BOD ⇅ Results

Results Screen - Deleting

Selection within the set-up menu allows the user to delete one (current) or all batches. By deleting all this resets the sample and batch ID to 1. By choosing to delete one batch (current), batch ID number stays the same; but the sample ID number reverts back to 1.

S(id)	Vt/Ve	S(0)	S(n)	BOD	DD:HH
1	5.00	5.86	5.86	2.80	3:0
2	5.00	13.75	7.46	34.25	3:0
3					
4					
5					
6					
7					
8					
9					
10	5.00	12.79	7.07	31.40	3:0

Setup BOD ⇅ **Results**

! All batches will be deleted
ESC key to cancel,
CLR key to continue

S(id)	Vt/Ve	S(0)	S(n)	BOD	DD:HH
1	5.00	5.86	5.86	2.80	3:0
2	5.00	13.75	7.46	34.25	3:0
3					
4					
5					
6					
7					
8					
9					
10	5.00	12.79	7.07	31.40	3:0

Setup BOD ⇅ **Results**

! Current batch will be deleted
Press ESC key to cancel,
Press CLR key to continue

BOD Set Up Parameters

The following section details the set-up modes available to the user on the BOD set-up menu screen:



BOD Batch ID

This option allows the user to enter a 2 digit batch ID number from 01 to 20. Enter the value using the keypad. Press the STO key to accept the value.



Sample ID

This option allows the user to enter a 2 digit sample ID number from 01 to 10. Enter the value using the keypad. Press the STO key to accept the value.

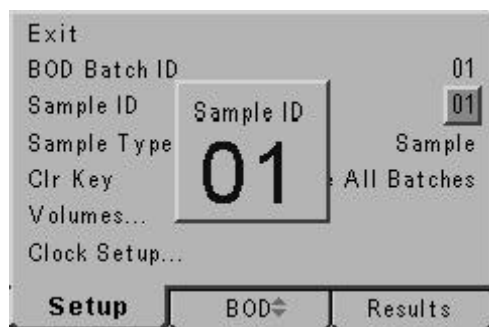

Sample Type

This option toggles between Sample and Blank.



Clr Key

This option toggles between Delete All Batches and Delete Current Batch.



Volumes...

Sample value (Ve) ml allows the user to set the required sample Ve.
Total volume (Vt) allows the user to set the required total volume Vt.

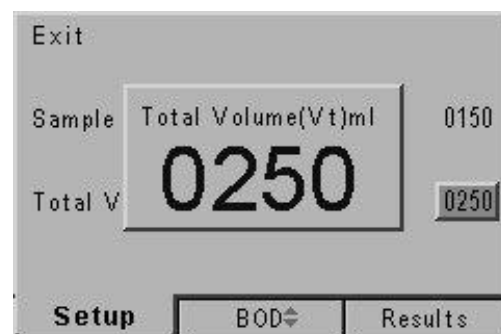
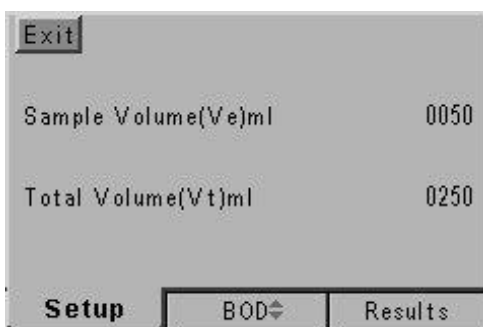

Clock Setup...

Refer Section 3.2.10 Set Up Parameters

BOD Process

The BOD process begins with the preparation of the samples and blanks (if required). Sample volume and total volume are both required to be entered by the user for every blank/sample.

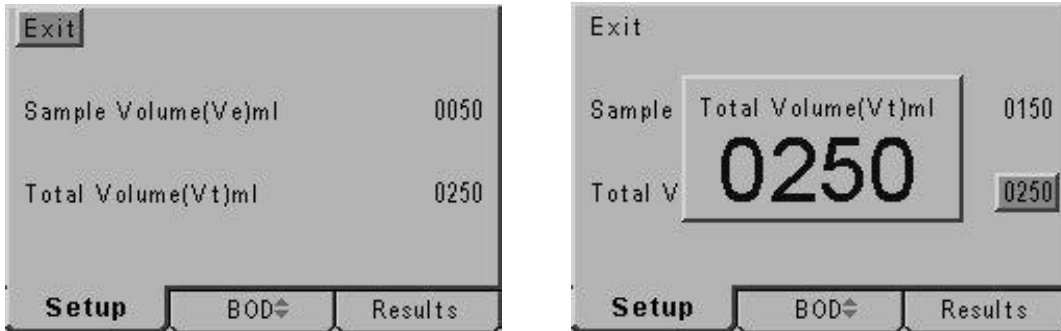

Once the Blank measurement is taken, the cursor will automatically move down to the sample square, ready for the user to input the first sample measurement. If the user wishes to repeat the blank measurement, the sample type must be changed to blank in the BOD set-up menu (providing 24 hours has not elapsed from the previous measurement). The user can continue to input samples and their respective volumes, until they have finished the batch. The batch does not need to consist of 10 samples, the user can finish entering the day (0) samples at any time. If the user forgets the blank, providing 24 hours has not passed since the first sample reading on day (0) the user can select blank for sample type and continue to store the blank day (0) reading.

Once 24 hours has passed from the oldest day (0) reading (sample/blank), the cursor will automatically move to the right side to continue to store day (n) readings. After each day (n) reading is stored the user is given the chance to move onto the next sample number. If they do not, the BOD answer is shown on the measuring screen (minus endpoint icon). Once the user is on the right hand side of the screen, they are unable to go back and repeat any day (0) measurement, unless they delete the batch. Deleting the batch erases any results stored in that batch from sample 1 to 10.

When displaying the BOD answer, if there is only one blank reading day (0) or day (n) but not both, then the BOD answer is calculated without blank criteria.

Overwrite

You can overwrite a day (0) or day (n) reading providing 24 hours hasn't elapsed from any initial reading in said batch. If you overwrite a day (n) reading the BOD result is updated straight away with the new answer if there is one.

BOD Calculation

Using the two BSI Standards for BOD calculation (with/without blank solution): EN 1889-1:1998 and EN 1889-2:1998. There are three conditions that need to be met for a successful BOD answer.

C1 = is the dissolved oxygen of the sample on day (0).

C2 = is the dissolved oxygen of the sample on day (n).

C3 = is the dissolved oxygen of the blank sample on day (0).

C4 = is the dissolved oxygen of the blank sample on day (n).

Ve = is the volume sample within the test solution.

Vt = is the total volume of the test solution.

Condition 1 - with blank

During the course of (n) days the dissolved oxygen measurement shouldn't fall by more than 1.5 mg/l.

Condition 2/3 – with/out blank

BOD answer is evaluated providing the following conditions are met.

$(C1/3) \leq (C1 - C2) \leq ((2*C1)/3)$ broken down into two parts.

$(C1/3) \leq (C1 - C2)$ and

$(C1 - C2) \leq ((2*C1)/3)$

Failure of any of these conditions doesn't prevent an answer being displayed, but a warning message is displayed when viewing the results of the particular sample whose conditions failed.

BOD Calculation - with blank

$BOD = ((C1 - C2) - ((Vt - Ve)/Vt) * (C3 - C4)) * (Vt/Ve)$

BOD Calculation - without blank

$BOD = (C1 - C2)$

General Points

Batches 1 to 20 work independently, allowing up to 20 batches to be running at the same time.

Blank time elapsed is shown on the BOD printout

When the second blank reading is stored, sample ID is set to 1; and the cursor moves to the sample square.

When changing to a different batch number, sample ID reverts back to 1 and sample type reverts back to blank.

The maximum number of days shown on the results screen and measuring screen after a complete BOD measurement is 99.

BOD Batch is a separate set-up parameter to Batch ID in G.L.P set-up, the two are treated independently of each other.

Cal reminders may be enabled, but do not function while using the BOD mode.

Results can be printed from the BOD measuring screen, and also the result screen

Warning Messages – BOD Conditions not met.

'The following BOD condition was not met. $((C1/3) \leq (C1-C2))$ Press any key to continue'

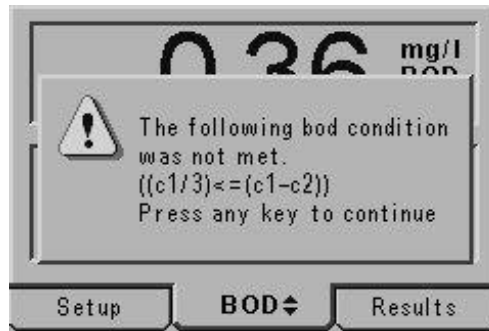

The first part of the BOD condition failed, e.g. the dissolved oxygen (c1) day (0)/3, was not less than or equal to dissolved oxygen (C1) day (0) – dissolved oxygen (C2) day (n). This does not prevent the answer being displayed, but does warrant a warning as it is a condition of the BSI standards EN 1889-1:1998, EN 1889-2:1998.

The same explanation applies to the following warning message,

*'The following BOD condition was not met. $((C1-C2) \leq ((2 * C1)/3))$ Press any key to continue'*

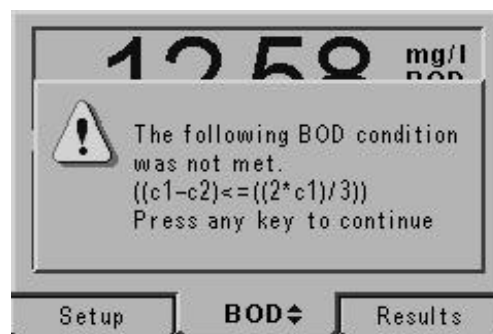

Warning Messages – General Messages.

'Oxygen consumed over n days, is greater than 1.5 mg/l. Press any key to continue.'

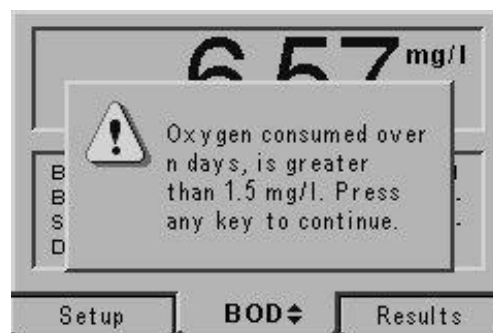

The above warning message alerts the user to a possible contamination within the blank samples. It is a condition of the BSI standard that over n days the oxygen within the blank should not exceed 1.5 mg/l.

'Overwrite existing blank STO Key to continue ESC Key to cancel.' &
'Overwrite existing sample STO Key to continue ESC Key to cancel.'

There is a blank/sample reading already stored, the BOD time limit of 24 hours has not expired, therefore the user can overwrite the existing blank/sample measurement. If 24 hours has expired the appropriate message will be shown to indicate this.

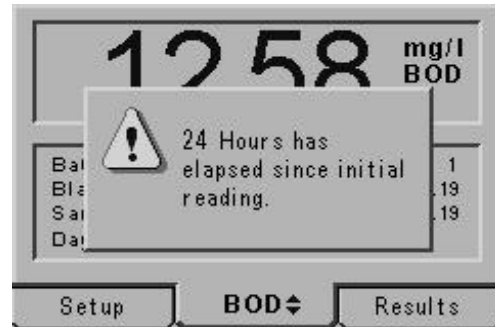

BOD Batch and Sample ID

'Value being adjusted is above upper limit'



This message will be shown during BOD Batch and Sample ID set up if the value selected is above the upper limit of 10 and 20 respectively.

3.5 Status Page

The Status page displays the current calibration information.

If no valid calibration data is stored (e.g. after a reset or a failed calibration) a warning screen will be shown.

The status page will show the calibration data in the order it was carried out. Date, time, temperature, and measurement.

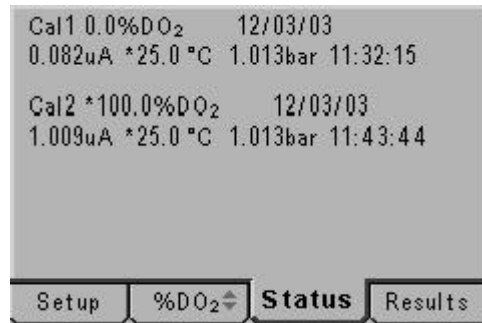

3.6 Results storage and display

The Model 9500 has a variety of options relating to the storage of data.



To initiate data logging the Data Log Event setting should be ENABLED.
By default this option is MANUAL.

The settings available are: Manual, Timed Interval, Endpoint Detection, Timed After Endpoint, Alarm Set, Alarm Clear, Alarm Set & Clear and Disabled. Press the Up/Down arrows to cycle through them.

- Manual** - logs results on pressing the STO key.
- Timed Interval** - logs on time and interval set by Data Log Interval in Hr:Min:Sec.
- Endpoint Detection** - logs data when the endpoint is detected.
- Timed After Endpoint** - logs at the Data Log Interval after the endpoint.
- Alarm Set** - data logs when the alarm set point is reached.
- Alarm Clear** - data logs when the alarm is cleared.
- Alarm Set & Clear** - data logs at the alarm set point and when the alarm condition clears.
- Disabled** - no data logging is possible when this option is selected.

The 9500 can log to either the memory or the printer. The memory can hold 250 data points which can be accessed via the Results screen, plus 20 BOD batches (10 samples per batch).

When the memory is full there are two options available regarding any additional logging. The default is STOP.

- Stop** - when the memory is full no further data logging can occur until some locations are deleted.
- Overwrite** overwrites data from the earlier storage point.

To prevent the accidental erasure of data the "Prompt Before Deleting" option can be either Enabled or Disabled.

The function of the CLR key can also be set in this menu. The options define the use of the delete key.

- Disabled** - no manual deleting of results is possible.
- Deletes Results Before** - deletes all results before the selected data point.
- Delete Results Since** - deletes all results since the selected data points.
- Deletes All Results** - deletes all stored results.

3.12.1 Accessing Stored Results

To access results which have been stored use the Right arrow key to select results. The most recently stored results will be displayed on the screen. If more results are stored than can fit on a single screen then a series of data screens are available. The current screen and total number of screens are shown in the bottom right hand corner of the screen.

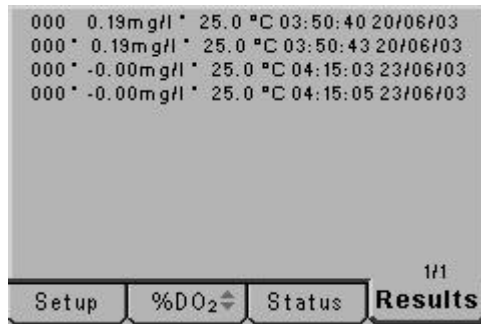

Other screens of data can be accessed using the Up/Down arrow keys.

The CLR key will delete data according to the set mode.

If the PROMPT BEFORE DELETING warning is set then a second CLR is required to delete results.

The PRINT key will print all stored data.

3.7 GLP Functions

A variety of GLP functions are available via the GLP Setup menu.



A reminder that calibration is due can be set via the Cal Reminder option. Once this option is set a valid calibration is required to use the 9500 after the time limit has elapsed. This option is DISABLED by default.

The interval time is set in hours on this menu.

NOTE: A calibration should be performed immediately after the setting of this value to reset the clock. This should be done as soon as set up is complete.

The on screen reminder can be accompanied by an audible alarm. This is set using the audible alarm setting on this menu.

NOTE: The use of the Calibration Reminder feature will prevent the user from performing measurements with the 9500 until a valid calibration is carried out.

The user and batch ID can be used to identify sets of samples and a specific user. This information is printed when data is output to the printer. The batch number is also stored in the results memory.

3.7.1 Security

To control access to set up options and data manipulation functions a security code can be set using this menu. When enabled a password is required to make any changes to the set up menus.

When the code is ENABLED a user can measure a sample, log data and calibrate the unit, but cannot change settings within the set up screens until a valid password is entered.

Section 4

Maintenance

4.1 General

The Model 9500 is designed to give optimum performance with minimum maintenance. It is only necessary to keep the external surfaces clean and free from dust. To give added protection when the unit is not in use the unit should be disconnected from the mains supply and covered with the optional dust cover (060 406). For longer term storage or re-shipment it is recommended that the unit be returned to the original packing case.

4.2 Probe Care and Maintenance

Although the oxygen probe is supplied in a clean and tested condition it may, after some time, become sluggish or erratic due to contamination of the gold cathode, silver anode or membrane.

a) Membrane Replacement

1. Hold the probe in a vertical position and carefully unscrew the membrane module.
2. Take the new membrane module and holding it in a vertical position, fill with O₂ electrolyte (5% KCl).
3. Still holding the module in a vertical position, screw the probe slowly down onto the thread, allowing excess electrolyte to escape through the screw thread. Ensure no air bubbles are present and the membrane is not creased.

b) Cathode and Anode Cleaning

The gold cathode tip can be re-polished using a fine abrasive ("crocus paper") material. Lay the abrasive sheet on a flat surface, hold the probe in a vertical position and gently polish by moving the tip over the sheet in a circular motion.

A toothbrush dipped in diluted ammonia solution will remove any deposits from the silver anode. Rinse with deionised water prior to re-assembly. If the probe is not to be used for 24 hours, store with the protective sheath fitted to prevent the electrolyte from drying out due to evaporation through the membrane, which is porous to water vapour as well as oxygen. If the probe is disconnected from the unit or a new membrane has been fitted, it will be necessary to allow the probe to polarise before stable readings can be obtained.

Polarisation will normally be achieved within 30 minutes.

Section 5

Optional Accessories

5.1 Optional Accessories

The following list of items are available for use with the Model 9500:

552 050	B.O.D. Kit
983 030	Zero Powder
522 019	Membrane Kit & KCl
060 406	Dust Cover
037 701	IrDA/Serial printer supplied with roll of thermal paper, serial connection lead, power supply and power connection lead (UK)
037 702	Paper Roll
050 002	Serial communication software (3½" disk)
037 801	Interface Cable Kit
Stirrers	
037 901	Bench stirrer (battery operated)
903 311	Extended length electrode rod (recommended for use with bench stirrer)
Power Supplies	
021 030	U.K. 230V Power Supply
021 031	European 230V Power Supply
021 032	U.S. 115V Power Supply
021 033	230V leaded Power Supply

5.2 Spares

522 023	Replacement DO ₂ probe
522 019	Membrane kit & KCl

Section 6

Interfacing

6.1 Analogue

All units are provided with 2 x 4mm sockets, marked as ANALOG OUT, on the rear panel. An analogue output voltage of 1mV per least significant digit is available from these sockets.

6.2 RS232

The Bi-directional RS232 interface is available on the rear panel 9 way D type connector. The connections are as follows:

DCD 1	- LINKED TO DTR AND DSR
RXD 2	- INPUT TO 9500
TXD 3	- OUTPUT FROM 9500
DTR 4	- LINKED TO DCD AND DSR
GND 5	
DSR 6	- LINKED TO DCD AND DTR
RTS 7	- OUTPUT FROM 9500
CTS 8	- INPUT TO 9500

Suggested interconnections are detailed below:

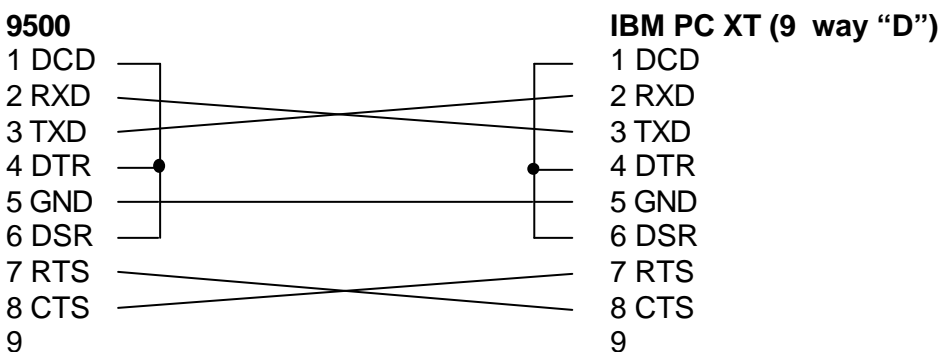
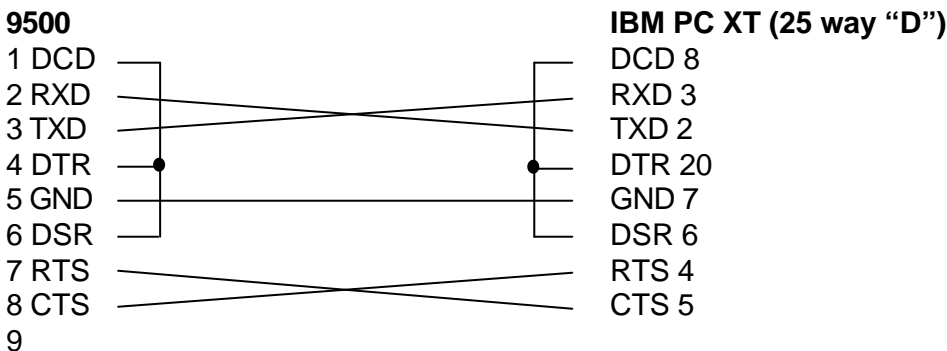

NOTE: Interface Cable (Order Code: 013 203) is required.

Interfacing (continued)

The RS232 communications parameters on the computer or printer need to be set to match those of the Model 9500, as detailed below:

1200 Baud		9600 Baud
7 Data Bits		8 data bits
Odd Parity	OR	No parity
1 Stop Bit		1 stop bit

Setting of these options is detailed in Section 3.2.8.

The Model 9500 supports both hardware (CTS/RTS) flow control and software XON/XOFF flow control.

Pressing the PRINT key outputs from the RS232 interface.

Sending an ASCII "D" to the 9500 causes a printout of the current displayed reading plus sample number.

Sending an ASCII "C" causes a printout of the last calibration parameters.

Sending an ASCII "P" causes a printout of the stored readings.

6.3 Keypad Emulation

Keypad remote control using RS232 interface:

7	- Instrument On / Standby / Escape
1	- Calibrate / Memory Clear
9	- Print
8	- Up Arrow
2	- Down Arrow
4	- Left Arrow
6	- Right Arrow
3 or 5	- Enter / Store

6.4 Printing

A 32 column serial printer (037 701) is available for use with the Model 9500.

There are two methods of connecting the serial printer to the Model 9500:

- a) IrDA - the IrDA interface is a line of sight, wireless communication protocol. The IrDA sensor (located on the front left hand corner of the printer) should be in line with the Ir window on the side of the 9500. The Ir icon on the symbol display indicates whether the units are attempting to connect (single icon flashing) or connected (two icons).
- b) Connect serial cable supplied with the printer to the 9 way socket located on the rear panel of the instrument.

To initiate a print out of data press the print key.

When the first print is performed a header section will be printed showing:

Instrument name
Time and Date
Spacing for entry of Operator & User ID
Operator ID number
Most recent calibration information

This will be followed by results data dependent on mode selected. Details will also be given on temperature. Time and date of the stored readings will be displayed.

An asterisk (*) indicates that manual temperature compensation is being used.

Each reading will be identified by a batch number.

A calibration will reset the printout and the header information will be re-printed.

To obtain a print out of stored readings, enter the RESULTS MODE and press the print key. A print out of all filled memory locations will then be generated.

6.5 Alarm Outputs

The 9500 provides two alarm outputs. These can be accessed using the two 4mm connectors on the rear of the 9500. They are open collector outputs. To set the alarm limits at which these are activated, please refer to section **3.2.4**.

To use the alarm outputs, they should be ENABLED in the Alarms Setup screen see section **3.2.4**. The alarm outputs will remain active until the alarm condition is no longer evident or the alarm limits are reset in the Alarm Set up menu.

For the Hi alarm output please use the Red 4mm phone connector.

For the Low alarm output please use the Black 4mm Phono connector.

For further information please contact your local distributor or the manufacturer.

Section 7

Troubleshooting and functional checks

7.1 Troubleshooting

Fault	Possible Cause	Action
No display	Check power supply	Check that correct 9V ac power supply is connected and switched on.
Erratic display	Check power supply	Unit must be used with supplied 9V ac power supply. Usage of other units will cause the 9500 not to operate.
Unable to calibrate to 100%	Calibrating to previously set value	Manually reset value to 100%.
Permanently reading zero	Membrane not fitted Membrane damaged Membrane not filled with KCl Probe defective	Fit membrane. Replace membrane. Fill or replace membrane. Replace probe.
Unable to calibrate	Sensor tip may be tarnished Membrane damaged	Clean the tip or replace the membrane. Replace membrane.
Erratic/slow response	Air bubbles inside the membrane cap	Refill or replace membrane.
	Coating of membrane due to use in oils or slurries, strong solvents, acids or alkalis.	Replace membrane.
	Probe defective	Replace probe.
Measurement errors	Zero solution will absorb oxygen if left open	Use fresh solution and re-calibrate.
	Incorrect salinity	Reset salinity values.
	Calibration error	Recalibrate with fresh solution.
	Contaminated solution	Replace solution.
	Incorrect standards	Replace standards.
Incorrect barometric pressure	Reset barometric pressure.	
Will not print	IrDA Connection broken	Line up units or alternatively use supplied RS232 connector.
	Paper out	The feed light on the printer will flash if the unit requires paper.
	Battery flat	Connect ac power supply.

If the above does not answer your query try the FAQ section on the www.Jenway.com Website.

HEALTH & SAFETY

PRODUCT: Potassium Chloride Solution

PHYSICAL DATA

Description: Colourless solution

Specific Gravity: 1.0

Solubility in water: miscible in all proportions

HEALTH HAZARD - May be harmful if ingested in quantity, causing nausea, vomiting and diarrhoea. May irritate eyes.

FIRST AID

Eyes	Irrigate thoroughly with water. If discomfort persists OBTAIN MEDICAL ATTENTION.
Lungs	Remove from exposure.
Skin	Wash off thoroughly with soap and water.
Mouth	Wash out mouth thoroughly with water. In severe cases OBTAIN MEDICAL ATTENTION.

PRODUCT: Sodium Sulphite Anhydrous

PHYSICAL DATA

Description: White Powder

Specific Gravity: 2.63

Solubility in water: very soluble

HEALTH HAZARD - If ingested in quantity can cause gastric irritation, colic, diarrhoea, central nervous system depression and death, due to liberation of sulphur dioxide. Irritating to skin, eyes and respiratory system. Used in controlled quantities as a food preservative and antioxidant.

FIRST AID

Eyes	Irrigate thoroughly with water for at least 10 minutes. OBTAIN MEDICAL ATTENTION.
Lungs	Remove from exposure, rest and keep warm. In severe cases OBTAIN MEDICAL ATTENTION.
Skin	Wash off thoroughly with water. Remove contaminated clothing and wash before re-use. In severe cases OBTAIN MEDICAL ATTENTION.
Mouth	Wash out mouth thoroughly with water and give plenty to drink. In severe cases OBTAIN MEDICAL ATTENTION.

EC Declaration of Conformity

JENWAY Model 9500 Dissolved Oxygen Meter complies with the following European Standards:

EN 50081-1:1992 Electromagnetic compatibility - Generic emission standard

EN 50082-1:1992 Electromagnetic compatibility - Generic immunity standard (Performance criterion B)

EN 61010-1:2001 Safety requirements for electrical equipment for measurement, control and laboratory use

Following the provision of:

EMC Directive - 89/336/EEC and Low Voltage Directive - 73/23/EEC



Thank you for reading this data sheet.

For pricing or for further information, please contact us at our UK Office, using the details below.



UK Office

Keison Products,

P.O. Box 2124, Chelmsford, Essex, CM1 3UP, England.

Tel: +44 (0)330 088 0560

Fax: +44 (0)1245 808399

Email: sales@keison.co.uk

Please note - Product designs and specifications are subject to change without notice. The user is responsible for determining the suitability of this product.