

AFU 2 & AFU 4



PRE-OPERATIONAL WARNINGS







GB

Please Read Carefully and Fully Understand

This manual is for use by personnel trained in the use and care of compressed-air airline breathing apparatus, and MUST NOT be used as a self-teaching guide by untrained users. Failure to understand or adhere to the **AFU 2 / AFU 4** User Instructions may result in injury or death.

Scott Safety has taken great care to ensure that the information in this manual is accurate, complete and clear. However, Training and Technical Support Services will be pleased to clarify any points in the manual and answer questions on compressed-air airline breathing apparatus.

The following warnings are in accordance with certifying authority requirements and apply to the use of breathing apparatus in general:

-  **This equipment must only be used by persons fully trained in the use and care of compressed-air airline breathing apparatus.**
-  **The quality of air used to supply compressed-air airline breathing apparatus must meet the requirements of EN 12021 : 1999. The level of contaminants shall not exceed the maximum permitted exposure level. Please refer to National Regulations for guidance.**
-  **Scott Safety recommends that the air supply is regularly tested to ensure compliance with these requirements.**
-  **AFU 2 and AFU 4 are only designed to remove water, oil and debris from the air supply. AFU 2 and AFU 4 WILL NOT remove carbon monoxide (CO), carbon dioxide (CO2) or other toxic gases or fumes from the air supply.**
-  **Ensure that the selection of equipment is sufficient for the tasks being undertaken and the hazards likely to be encountered. Please refer to National Regulations for guidance. Guidance can be found within the Health and Safety Executive publication: HS-G(53) - Respiratory Protective Equipment, a Practical Guide for Users.**
-  **Ensure that the air supply pressure and flow is sufficient with regard to the number of apparatus wearers breathing from the supply. For further guidance, please refer to Section - Supply Pressure and Flow.**
-  **All breathing apparatus and breathable air supply equipment must be regularly tested and maintained in accordance with National Regulations. In the UK, equipment users should refer to the Health and Safety at Work Act (1974), Pressure Systems and Transportable Gas Container Regulations (1989) and the Personal Protective Equipment Directive (1993).**

DISCLAIMER

Failure to comply with these instructions or misuse of the apparatus may result in: death, injury or material damage, and invalidate any warranty or insurance claims.

COPYRIGHT

This manual must not be copied in part or whole, or used for purposes other than its intended purpose without the written permission of **Scott Safety**.

INTRODUCTION

BREATHABLE AIR

Air used to supply or charge breathing air may be natural or synthetic and must comply with EN 12021 : 1999 or AS/NZS1715 : 1994.

SUPPLY PRESSURE AND FLOW - DEMAND VALVE-FED

The airline supply pressure and flow must meet the following requirements for use with demand valve-fed apparatus' being supplied from a single source.

| No. of BA Wearers | Supply Pressure (bar) | Airflow (L/min.) |
|-------------------|-----------------------|------------------|
| 1 | 5.0 - 9.0 | 300 |
| 2 (1 Pair) | 5.0 - 9.0 | 450 |
| 3 | 5.0 - 9.0 | 750 |
| 4 (2 Pairs) | 5.0 - 9.0 | 900 |

Table 1: Supply Pressure and Flow - Demand Valve-Fed Apparatus

Generally, each additional wearer requires an extra 150 litres per minute; each additional pair of wearers requires 300 L/min for one wearer and 450 L/min for two wearers. All measurements must be taken at the wearer end of the airline.

SUPPLY PRESSURE AND FLOW - CONSTANT FLOW

The airline supply pressure and flow must meet the following requirements for use with constant flow apparatus' being supplied from a single source.

| No. of BA Wearers | Supply Pressure (bar) | Airflow (L/min.) |
|-------------------|-----------------------|------------------|
| 1 | 5.0 - 9.0 | 300 - 500 |
| 2 (1 Pair) | 5.0 - 9.0 | 600 - 1000 |
| 3 | 5.0 - 9.0 | 900 - 1500 |
| 4 (2 Pairs) | 5.0 - 9.0 | 1200 - 2000 |

Table 2: Supply Pressure and Flow - Constant Flow Apparatus

For each additional wearer, add a minimum of 300 to 500 litres per minute. All measurements must be taken at the wearer end of the airline.

PERSONNEL TRAINING

Personnel who use compressed-air airline breathing apparatus must be fully trained in accordance with these instructions and National Regulations.

These instructions cannot replace an accredited training course run by fully qualified instructors in the proper and safe use of **Scott Safety** compressed-air airline breathing apparatus.

Please contact **Training and Technical Support Services** or your distributor for training course details.

Training and Technical Support Services:

Scott Safety
Pimbo Road,
West Pimbo,
Skelmersdale,
Lancashire,
WN8 9RA,
England.

Tel: +44 (0) 1695 711711

Fax: +44 (0) 1695 711775

SERVICING

In order to maintain optimum performance, **AFU 2** and **AFU 4** must be tested regularly and serviced at scheduled intervals by personnel who have completed a formal training course and hold a current certificate for the servicing and repair of **Scott Safety** compressed-air airline breathing apparatus.

Instructions for the replacement of filter elements are contained within this manual. All other instructions for servicing are contained in the **Scott Safety** Service Manual, copies of which can only be obtained by registered holders of a current certificate.

Your distributor or **Training and Technical Support Services** will be pleased to provide training course details and quotes for service contracts. Please see above for contact details.

TECHNICAL DESCRIPTION

The **Scott Safety AFU** is an Airline Filter Unit designed to remove dirt particles, water and oil from a breathable air supply for use with compressed-air airline breathing apparatus.

Scott Safety AFU is available in two sizes, dependant upon the maximum flow-rate required:

AFU 2 has a maximum flow capacity of 13 litres per second (28 cubic feet per minute) at 7 Bar G (100 psi G). This unit can only be used to supply a maximum of 3 wearers of demand valve-fed apparatus or 2 wearers of constant-flow apparatus.

AFU 4 has a maximum flow capacity of 25 litres per second (53 cubic feet per minute) at 7 Bar G (100 psi G). This will allow up to 6 wearers (3 pairs) of demand valve-fed apparatus or 4 wearers (2 pairs) of constant-flow apparatus.

These units are available either mounted in a tubular steel floor stand or in a box enclosure suitable for wall-mounting.

All units work on the same principle, utilising a three-stage filtration system.

The first stage AO Filter is a high-efficiency coalescing filter for the removal of dirt particles down to 1×10^{-6} metres in size.

The second stage AA Filter is a high-efficiency coalescing filter for the removal of oil mist/ water aerosol and dirt particles down to 0.01×10^{-6} metres in size with a maximum remaining oil content of $0.01\text{mg}/\text{m}^3$.

An auto-drain valve is fitted to each of the first and second stage filter housings to allow water and other liquids to be safely drained away.

The third stage AC Filter is an absorption bed of activated carbon for the removal of oil vapours and odours. The air supply following this stage has a maximum remaining oil content of $0.003\text{mg}/\text{m}^3$ at a temperature of 21°C .

The maximum unit inlet pressure is 16 bar. If the supply pressure exceeds this, it will be necessary to fit an in-line regulator and pressure relief valve (PRV) to protect the **AFU** from over-pressurisation. A pressure gauge on the inlet provides a clear indication of the supply pressure.

The 3/8" BSP male inlet connection on the pressure gauge can accommodate a suitable supply hose or medium-pressure airline coupling.

The outlets are CEJN female couplings, of which, two are provided on the **AFU 2** and four on the **AFU 4**.

The filter elements are located in robust metal housings fitted to a central yoke. The housings may be removed by hand to facilitate quick and easy replacement of filter elements.

The element should be changed as per our recommendations.

The recommended frequency of filter element replacement is as follows:

| Filter Element | Replace After |
|-------------------------------|------------------------------|
| First Stage - (AO Filter) | Maximum 6000 hours use |
| | OR Every 12 months |
| Second Stage - (AA Filter) | Maximum 6000 hours use |
| | OR Every 12 months |
| Third Stage - (AC Filter) | Maximum 1000 hours use |
| | OR Every 2 months |

Table 3: Frequency of Filter Element Replacement

Note: It may be necessary to change filter elements more frequently if the airline supply is heavily contaminated.

INSTALLATION AND OPERATING PROCEDURE

CHECK COMPRESSOR/SUPPLY

Check compressor inlet to verify that there are no obstructions and ensure that no exhaust fumes, vapours or other contaminants enter the inlet connection.

Ensure that the compressor is operating correctly and not overheating.

WARNING:

The AFU WILL NOT remove contaminants such as Carbon Monoxide (CO), Carbon Dioxide (CO2), or other harmful gases of vapours.

If these or other harmful gases/vapours are present, a suitable air purifier MUST be used.

If using cylinder supply, ensure that sufficient air is available for the anticipated tasks.

PURGE AIR

Before installing the **AFU** to an airline supply, purge the supply hose with air to remove any water or loose debris which may have become trapped within the line.

CHECK HOSES

Ensure that all supply hoses are of a type approved for the supply of breathing air and that they are clean and un-damaged. Check the operation of all hose couplings to ensure that they connect and disconnect correctly.

CHECK APPARATUS

Check the **AFU** to ensure that all components are clean and un-damaged. Any components showing signs of damage should be replaced immediately.

Check breathing apparatus and associated equipment in accordance with the manufacturer's instructions, ensuring that all components are clean and un-damaged.

CONNECT SUPPLY

Connect breathing air supply to the **AFU** inlet and ensure that the flow is in the correct direction (indicated by an arrow on top of the filters). Check that inlet pressure does not exceed 16 bar.

CAUTION:

The AFU MUST be positioned vertically or it will not function correctly.

Ensure that the positioning of the AFU is such that it is unlikely to be damaged, tilted or overturned.

Ensure that the hose cannot become kinked or constricted.

The second stage Bulls eye is showing a white colour. Renew filter element if the red 'warning' indicator is showing.

Listen for any audible leaks and ensure that all hose connections and filter retainers are secure. Rectify faults immediately.

CHECK SUPPLY PRESSURE AND FLOW

Connect breathing apparatus supply hose to the **AFU** outlet. Check that supply pressure and flow at the extremity of the hose, adjacent to the wearer, are in accordance with the figures given in Table 1 or 2 (as appropriate).

If the **AFU** inlet pressure is sufficient but the hose outlet pressure is low, check to ensure that the filters do not need replacing. Replace the filters if required.

Once fully satisfied that the equipment is functioning correctly, proceed to undertake the required tasks.

WARNING:

During use, the airline supply equipment must be under constant supervision in order to ensure that an adequate air supply is maintained and to alert wearers of potential hazards.

SHUTTING DOWN PROCEDURE

REMOVE BREATHING APPARATUS

All wearers must remove breathing apparatus in accordance with the manufacturer's instructions.

ISOLATE/BLEED SUPPLY

Isolate the airline supply and release pressure within the supply line using bleed valve, (if fitted), or by venting through the breathing apparatus.

DISCONNECT HOSES/EQUIPMENT

Disconnect all hoses from equipment. Coil all hoses and connect hose end couplings for safe storage.

CLEAN, EXAMINE AND TEST EQUIPMENT

Clean and test all equipment thoroughly and inspect for signs of wear or damage in accordance with the manufacturer's instructions. All faults must be rectified immediately.

RECORD DETAILS OF USE

A record must be maintained and kept detailing the use of airline breathing apparatus and associated equipment.

Information recorded usually includes:

Name and address of the employer responsible for the equipment.

Particulars of the equipment used, including details of the manufacturer, model number or mark sufficient to enable clear identification.

Date of use and length of time the equipment was in use.

Date of the examination together with the name, signature or unique authentication mark of the examiner.

Condition of the equipment and details of any rectification work carried out.

CHECK AFU

CHECK VENTS

Depress the small black plastic hose tail on the underside of housing and ensure that it operates correctly, (there should only be light spring-pressure resistance). If the vent valve is sticking, the **AFU** must be sent for Servicing. The weeping of liquid from the vent valve indicates a malfunction of the auto-drain valve. If this is the case, the **AFU** should be sent for Servicing.

CHECK HOUSING

Check the housing for signs of abrasion, corrosion or damage. If a fault is found, the unit must be withdrawn from service and the fault rectified in accordance with the Service Manual.

CHECK PRESSURE GAUGE

Check inlet pressure gauge to ensure that it is un-damaged and functioning correctly.

WARNING:

An inoperative pressure gauge may result in hazardous dismantling of the unit whilst it is still pressurised.

ROUTINE MAINTENANCE

FIRST STAGE (AO) AND SECOND STAGE (AA) FILTER REPLACEMENT

CAUTION:

DO NOT use solvents to clean any part of the equipment.

Note:

The numbers shown below in brackets, eg (1), refer to item numbers on the spare parts list contained in **Section - Spare Parts** of this manual.

For part number information, please refer to **Section - Spare Parts** of this manual.

The first and second stage filter elements will operate indefinitely when only removing liquids from the supply. However, the build-up of solid contaminants becoming trapped will lead to a pressure drop across the filter element, indicated by the red 'warning' indicator operating.

It is recommended that filter elements are renewed after a maximum period of 6000 hours in use or every 12 months, whichever is sooner.

Isolate the **AFU** from compressed-air supply.

Depress the small plastic hose tail at the bottom of housing to de-pressurise.

Unscrew lower housing anti-clockwise from yoke, (a warning whistle will sound if the housing has not been fully de-pressurised). If this occurs, re-tighten housing and repeat the step above before re-commencing.

Unscrew filter element (1) or (2) and discard. Fit replacement element, ensuring that replacement O-Ring is also fitted. Ensure that filters are fitted in the correct position, ie: AO Filter (1) is on the left side, (as illustrated) and AA Filter (2) is on the right.

Fit new O-Ring to filter housing. Lubricate O-Ring with silicone grease if required.

Inspect inside of filter housings and ensure that they are clean and undamaged. Clean housing using a warm water and detergent solution. If dirt or liquid is present, check to confirm if the unit is functioning correctly. If the auto-drain unit is malfunctioning, the **AFU** should be sent for Servicing.

Once satisfied with the unit, re-fit housing to yoke by turning in a clockwise direction to secure. Tighten hand-tight only. **DO NOT** over-tighten.

Connect unit to a suitable airline supply and pressurise to check for leaks.

Once completely satisfied that the equipment is in good working order, it may be returned to service.

THIRD STAGE (AC) FILTER REPLACEMENT

CAUTION:

DO NOT use solvents to clean any part of the equipment.

Note:

The number shown below in brackets, ie (3), refers to the item number on the spare parts list contained in **Section - Spare Parts** of this manual.

For part number information, please refer to **Section - Spare Parts** of this manual.

The third stage filter element has a recommended maximum service life of 1000 hours or 2 months, whichever is sooner. The pressure differential will not increase during this time, but the odour of oil within the air will become more prevalent.

Isolate the **AFU** from compressed-air supply.

Depress vent valve drain at the bottom of housing to de-pressurise.

Unscrew upper housing anti-clockwise from yoke, (a warning whistle will sound if the housing has not been fully de-pressurised). If this occurs, re-tighten housing and repeat the step above before re-commencing.

Remove plug-in filter element (3) and discard. Fit replacement element, ensuring that replacement O-Ring is also fitted.

Fit new O-Ring to filter housing and lubricate O-Ring.

Inspect inside of filter housing and ensure that it is clean and undamaged. Clean housing using a warm water and detergent solution. Any signs of damage or corrosion should be rectified immediately.

Once satisfied with the unit, re-fit housing to yoke by turning in a clockwise direction to secure. Tighten hand-tight only. **DO NOT** over-tighten.

Connect unit to a suitable airline supply and pressurise to check for leaks.

Once completely satisfied that the equipment is in good working order, it may be returned to service.

SPARE PARTS

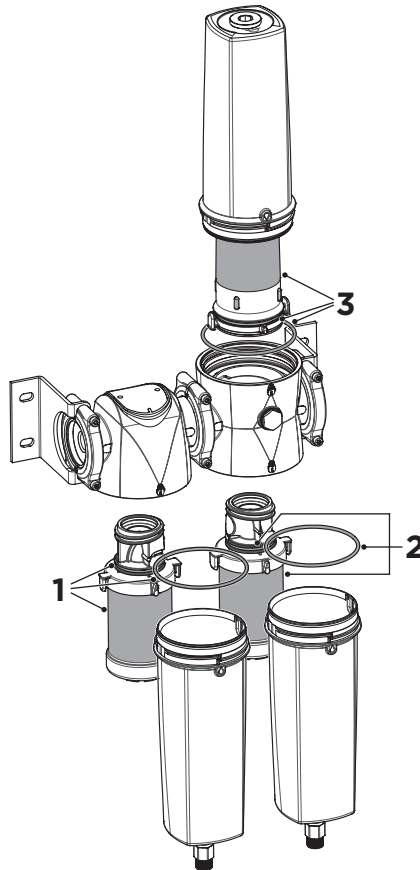

AFU 2

| Item No | Article No | Description |
|---------|------------|--|
| 1 | 2026220 | First stage (AO) filter element complete with O-Rings |
| 2 | 2026221 | Second stage (AA) filter element complete with O-Rings |
| 3 | 2026222 | Third stage (AC) filter element complete with O-Rings |

Note: For all other component details, please refer to Service Manual.

AFU 4

| Item No | Article No | Description |
|---------|------------|--|
| 1 | 2026216 | First stage (AO) filter element complete with O-Rings |
| 2 | 2026217 | Second stage (AA) filter element complete with O-Rings |
| 3 | 2026219 | Third stage (AC) filter element complete with O-Rings |

Note: For all other component details, please refer to Service Manual.



Thank you for reading this data sheet.

For pricing or for further information, please contact us at our UK Office, using the details below.



UK Office

Keison Products,

P.O. Box 2124, Chelmsford, Essex, CM1 3UP, England.

Tel: +44 (0)330 088 0560

Fax: +44 (0)1245 808399

Email: sales@keison.co.uk

Please note - Product designs and specifications are subject to change without notice. The user is responsible for determining the suitability of this product.